

DONJOY looking forward to your visit! Your telecommunications!



**东正科技有限公司**  
**DONJOY TECHNOLOGY CO.,LTD.**

地址: 温州空港新区港富路25号  
总机: 0577-86990888  
传真: 0577-86998000

Add: No.25 Gang fu Road, konggang  
new District, Longwan Wenzhou, China  
Tel: +86-577-86990888  
Fax: +86-577-86998000  
E-mail: donjoy@cndonjoy.com

[www.cndonjoy.com](http://www.cndonjoy.com)

法律声明:  
目录样册版权归东正所有, 如有抄袭, 必将追究其法律责任和经济赔偿。  
东正已获得国家版权局书刊号。东正诸多产品技术, 都具有专利保护, 如有抄袭, 必将追究法律责任和经济赔偿。

Legal statement:  
Copyright of the catalogue belongs to Donjoy. If there is plagiarism, it will be investigated for legal responsibility and economic compensation. Donjoy has been granted publications number by China's National Copyright. Donjoy products and technology with patent protection. If there is plagiarism, it will be investigated for legal responsibility and economic compensation.

# Controller

2023 / 控制器 智能制造



国家高新技术企业 专精特新企业

# Advantages



30 YEARS

30年的阀门研发与制造  
More than 30 years valve and pump R&d and Manufacturing

23 YEARS

23年的高洁净泵研发与制造  
More than 23 years high purity pump R&d and Manufacturing

18 YEARS

18年的阀门控制器研发与制造  
More than 18 years valve controller R&d and Manufacturing

15 YEARS

15年的清洗技术研发与制造  
More than 15 years Cleaning technology R&d and Manufacturing

300

300多人的专业团队  
A profession team of over 300 people

200

200多项知识产权  
More than 200 intellectual property rights

30

30多项国际权威认证  
More than 30 international authoritative certifications

20

20多项国家与省级荣誉  
More than 20 national and provincial honors certificates

超过10年研发经验  
工程师队伍  
We have more than 10 years experienced engineer team in R & D.

日本Mazak  
CNC复合型加工中心  
CNC切削中心  
CNC车床  
Japan Mazak  
CNC compound machining center  
CNC cutting center  
CNC lathe

发那科《Fanuc》  
全自动机器人生产线  
《Fanuc》 Automatic robot  
production line

高新技术企业、  
省著名商标、  
主任质量奖、4项发明、  
200余项专利  
New high-tech enterprise.  
Provincial famous trademark.  
Director's Quality Award.4 inventions  
More than 200 patents

欧盟CE  
美国3-A, FDA  
中国特种制造许可证 TS  
防爆认证ATEX CNEX  
European Union CE certificate  
USA 3-A, FDA  
China Special Manufacturing  
License TS  
ATEX CNEX

我们能为你提供  
定制化技术服务和制造,  
OEM ODM  
We can provide  
you OEM & ODM service

领先的检测手段,  
30多台专业检测设备和  
50多种检测方法, 确保  
每个产品性能和精度  
Advanced detection method.  
More than 30 pcs professional  
testing equipment. More than  
50 inspection ways, insure product  
performance and accuracy



30 YEARS

30年洁净领域的专注  
30 years of focus in the field of cleanliness

30 YEARS

30年工程应用经验与市场考验  
30 years of engineering application experience and market test

三十而立正蕴含着新的力量，  
未来我们将一如既往的致力于技术革新！  
We Donjoy have established for 30 years, still full of  
new energy, in the future we will stick to concentrate on  
technology innovation

# Introduction

东正创立于1993年，占地面积29000m<sup>2</sup>，注册资本1.0558亿元，员工300余人，技术团队30余人，200余项知识产权，国际权威认证30余项，国家与省级荣誉证书20余项，且拥有国际领先的加工技术和制造设备，如Mazak CNC四轴、五轴加工中心、复合型切削中心、FANUC机器人生产线以及各种国际领先的检测设备。

东正制造的产品远销全球并获得国内外用户高度好评，我们产品和技术涵盖高洁净泵、阀门控制技术、PID自控阀门、高洁净阀门、容器管道安全控制技术、容器清洗技术、容器管道照明技术、过滤技术以及高洁净管道和配件等。广泛应用于生物制药、食品饮料、酿酒、精细化工、日化洗涤、纺织印染、电池和新能源等工业领域。

Donjoy is founded in 1993, covers an area of 29,000 square meters, registered capital of 105.58 million yuan, we have more than 300 employees, we have more than 30 persons technical team, we have more than 200 intellectual property rights, we have more than 30 authoritative international certification, we have more than 20 national and provincial certifications, and has an international leader of first processing technology and manufacturing equipment, such as Mazak CNC four axis, five axis machining center, compound cutting center, FANUC robot production line and various international collar first detection equipment, etc.

The products manufactured by Donjoy are sold all over the world and are highly praised by domestic and overseas Products and technology cover high purity pump, valve control technology, PID automatic control valve, high purity valve, container pipeline safety control technology, container cleaning technology, container pipe road lighting technology, filtration technology and high purity pipes and accessories. Widely used in the biopharmaceuticals, food and beverage, wine, fine chemicals, daily chemical washing, textile printing and dyeing, battery and new energy and other industrial fields.









## 隔爆系列-阀门定位器-IL-TOP-21A31/21A32 Exd flameproof series-Valve positioner-IL-TOP-21A31/21A32

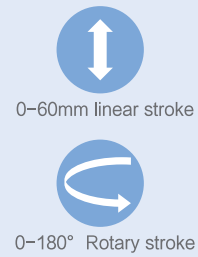

### 技术参数 Technical parameter

供电: DC24V ± 10%  
输入: 0/4-20mA; 0-5V/10V  
输出: 0/4-20mA; 0-5V/10V  
总线通讯: IO-Link; MOD BUS RS485

Power supply: DC24V ± 10%  
Input: 0/4-20mA; 0-5V/10V  
Output: 0/4-20mA; 0-5V/10V  
Bus communication: IO-Link; MOD BUS RS485



IL-TOP-21A31/21A32是一款隔爆设计的阀门定位器，它接收来自PLC/DCS或其他自控系统指令如0/4-20mA，0-5V/10V进行工作，同时反馈当前阀门位置信号到PLC/DCS等自控系统，也可通过IO-Link、MOD BUS RS485版本总线通讯。

The IL-TOP-21A31/21A32 is a flameproof design valve positioner. It receives instructions from PLC/DCS or other automatic control systems, such as 0/4-20mA, 0-5V/10V to work, at the same time feedback the current valve position signal to PLC/DCS and other automatic control systems. It can also communicate through IO-Link or MOD BUS RS485 version bus.

### 技术特点

- 单键自动整定功能
- 死区精度可设定
- 故障安全位置设定
- 中英文菜单设置
- 重复定位精度误差 ≤ 0.2%
- 阀位保持时不耗气
- 可曲线设置
- 隔爆、本安双认证
- IP66 防护等级

### Technical Features

- Single button self-tuning
- Configurable precision
- Configurable safe range
- English/Chinese menu setting
- Repeated positioning accuracy error
- No air consumption when valve position is held
- Adjustable curve can be set
- Intrinsic safety explosion-proof certificate
- IP66 protection grade



## 本安防爆系列-阀门定位器-IL-TOP-2231/2232 Intrinsic safety explosion-proof series-valve positioner-IL-TOP-2231/2232

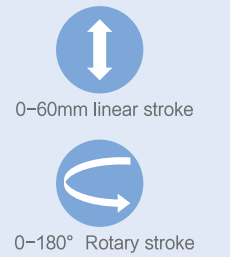

### 技术参数 Technical parameter

供电: DC24V ± 10%  
输入: 0/4-20mA; 0-5V/10V  
输出: 0/4-20mA; 0-5V/10V  
总线通讯: IO-Link; MOD BUS RS485

Power supply: DC24V ± 10%  
Input: 0/4-20mA; 0-5V/10V  
Output: 0/4-20mA; 0-5V/10V  
Bus communication: IO-Link; MOD BUS RS485



IL-TOP-2231/2232是一款本安防爆设计的阀门定位器，它接收来自PLC/DCS或其他自控系统指令如0/4-20mA，0-5V/10V进行工作，同时反馈当前阀门位置信号到PLC/DCS等自控系统，也可通过IO-Link、MOD BUS RS485版本总线通讯。

The IL-TOP-2231/2232 is an intrinsic safety design valve positioner. It receives instructions from PLC/DCS or other automatic control systems, such as 0/4-20mA, 0-5V/10V to work, at the same time feedback the current valve position signal to PLC/DCS and other automatic control systems. It can also communicate through IO-Link or MOD BUS RS485 version bus.

### 技术特点

- 单键自动整定功能
- 死区精度可设定
- 故障安全位置设定
- 中英文菜单设置
- 重复定位精度误差 ≤ 0.2%
- 阀位保持时不耗气
- 可曲线设置
- 本安双认证
- IP66 防护等级

### Technical Features

- Single button self-tuning
- Configurable precision
- Configurable safe range
- English/Chinese menu setting
- Repeated positioning accuracy error
- No air consumption when valve position is held
- Adjustable curve can be set
- Intrinsic safety explosion-proof certificate
- IP66 protection grade

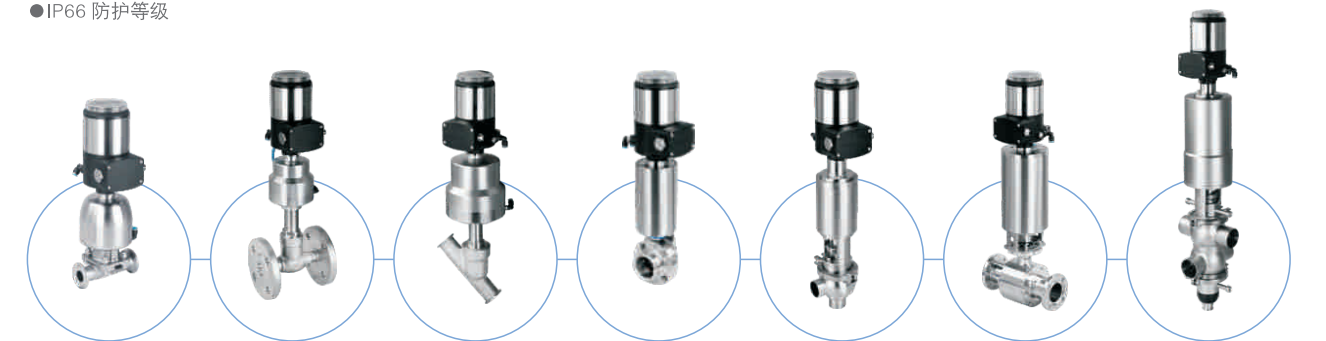



# 本安防爆系列-阀门定位器-IL-TOP-2201/2202 Intrinsic Safety Explosion-proof Series-Valve positioner -IL-TOP-2201/2202

# 本安防爆系列-阀门定位器-IL-TOP-1441/1442 Intrinsic Safety Explosion-proof Series-Valve positioner -IL-TOP-1441/1442



0-45mm linear stroke

## 技术参数 Technical parameter

供电: DC24V ± 10%  
输入: 0/4-20mA; 0-5V/10V  
输出: 0/4-20mA; 0-5V/10V  
总线通讯: IO-Link; MOD BUS RS485

Power supply: DC24V ± 10%  
Input: 0/4-20mA; 0-5V/10V  
Output: 0/4-20mA; 0-5V/10V  
Bus communication: IO-Link; MOD BUS RS485



0-180° Rotary stroke

## 技术参数 Technical parameter

供电: DC24V ± 10%  
输入: 0/4-20mA; 0-5V/10V  
输出: 0/4-20mA; 0-5V/10V  
总线通讯: IO-Link; MOD BUS RS485

Power supply: DC24V ± 10%  
Input: 0/4-20mA; 0-5V/10V  
Output: 0/4-20mA; 0-5V/10V  
Bus communication: IO-Link; MOD BUS RS485



IL-TOP-2201/2202是一款本安防爆设计的阀门定位器，它接收来自PLC/DCS或其他自控系统指令如0/4-20mA, 0-5V/10V进行工作，同时反馈当前阀门位置信号到PLC/DCS等自控系统，也可通过IO-Link、MOD BUS RS485版本总线通讯。

The IL-TOP-2201/2202 is an intrinsic safety flameproof design valve positioner. It receives instructions from PLC/DCS or other automatic control systems, such as 0/4-20mA, 0-5V/10V to work, at the same time feedback the current valve position signal to PLC/DCS and other automatic control systems. It can also communicate through IO-Link or MOD BUS RS485 version bus.

IL-TOP-1441/1442是一款本安防爆设计的阀门定位器，它接收来自PLC/DCS或其他自控系统指令如0/4-20mA, 0-5V/10V进行工作，同时反馈当前阀门位置信号到PLC/DCS等自控系统，也可通过IO-Link、MOD BUS RS485版本总线通讯。

The IL-TOP-1441/1442 is an intrinsic safety flameproof design valve positioner. It receives instructions from PLC/DCS or other automatic control systems, such as 0/4-20mA, 0-5V/10V to work, at the same time feedback the current valve position signal to PLC/DCS and other automatic control systems. It can also communicate through IO-Link or MOD BUS RS485 version bus.

## 技术特点

- 单键自动整定功能
- 死区精度可设定
- 故障安全位置设定
- 中英文菜单设置
- 重复定位精度误差 ≤ 0.2%
- 阀位保持时不耗气
- 调节曲线可设置
- 本安防爆认证
- IP66 防护等级

## Technical Features

- Single button self-tuning
- Configurable precision
- Configurable safe range
- English/Chinese menu setting
- Repeated positioning accuracy error
- No air consumption when valve position is held
- Adjustable curve can be set
- Intrinsic safety explosion-proof certificate
- IP66 protection grade



## 技术特点

- 单键自动整定功能
- 死区精度可设定
- 故障安全位置设定
- 中英文菜单设置
- 重复定位精度误差 ≤ 0.2%
- 阀位保持时不耗气
- 调节曲线可设置
- 本安防爆认证
- IP66 防护等级

## Technical Features

- Single button self-tuning
- Configurable precision
- Configurable safe range
- English/Chinese menu setting
- Repeated positioning accuracy error
- No air consumption when valve position is held
- Adjustable curve can be set
- Intrinsic safety explosion-proof certificate
- IP66 protection grade

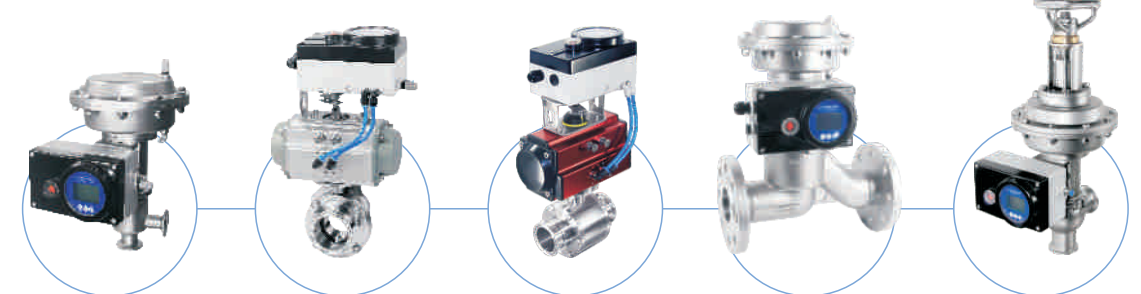



## 隔爆系列-阀门定位器-IL-TOP-22A41/22A42 Exd flameproof series-Valve positioner-IL-TOP-22A41/22A42

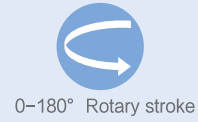

0-180° Rotary stroke

### 技术参数 Technical parameter

供电: DC24V ± 10%  
输入: 0/4-20mA; 0-5V/10V  
输出: 0/4-20mA; 0-5V/10V  
总线通讯: IO-Link; MOD BUS RS485

Power supply: DC24V ± 10%  
Input: 0/4-20mA; 0-5V/10V  
Output: 0/4-20mA; 0-5V/10V  
Bus communication: IO-Link; MOD BUS RS485



IL-TOP-21A41/21A42是一款隔爆设计的阀门定位器，它接收来自PLC/DCS或其他自控系统指令如0/4-20mA，0-5V/10V进行工作，同时反馈当前阀门位置信号到PLC/DCS等自控系统，也可通过IO-Link、MOD BUS RS485版本总线通讯。

IL-TOP-21A41/21A42 is a Ex d explosionproof valve positioner. It receives instructions from PLC/DCS or other automatic control systems, such as 0/4-20mA, 0-5V/10V, and feeds back the current valve position signal to PLC/DCS and other automatic control systems. It can also communicate through IO-Link or MOD BUS RS485 version bus.

### 技术特点

- 单键自动整定功能
- 死区精度可设定
- 故障安全位置设定
- 中英文菜单设置
- 重复定位精度误差 ≤ 0.2%
- 阀位保持时不耗气
- 可曲线设置
- 隔爆、本安双认证
- IP66 防护等级

### Technical Features

- Single key automatic setting function
- Precision of dead zone can be set
- Failsafe position setting
- English and Chinese menu Settings
- Repeated positioning accuracy error ≤ 0.2%
- No gas consumption when the valve position is maintained
- Curve setting
- Ex d explosion-proof, intrinsic safety double certification
- IP66 protection grade

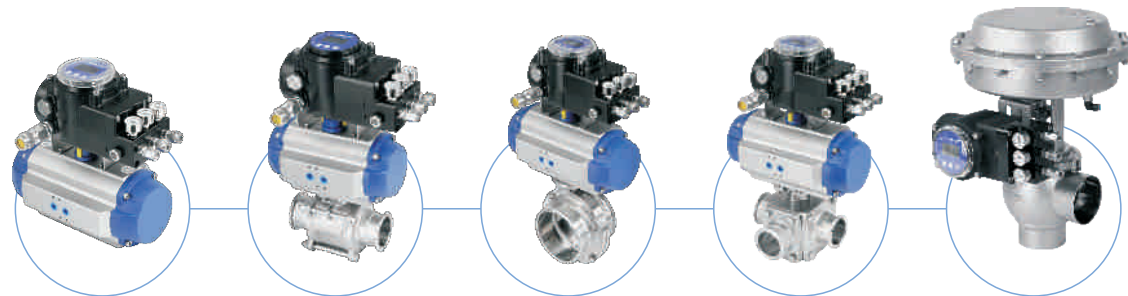

## 本安防爆系列-阀门定位器-IL-TOP-1891 Intrinsic safety explosion-proof series - Valve positioner -IL-TOP-1891

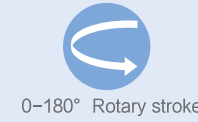

0-180° Rotary stroke

### 技术参数 Technical parameter

输入: 4-20mA  
输出: 4-20mA  
总线通讯: HART 6/7

Input: 4-20 mA  
Output: 4-20mA  
Bus communication: HART 6/7



IL-TOP-1891是一款本安防爆设计的阀门定位器，它接收来自PLC/DCS或其他自控系统指令如4-20mA进行工作，同时反馈当前阀门位置信号到PLC/DCS等自控系统，也可通过HART6/7版本总线通讯。

IL-TOP-1891 is a intrinsically safe explosion-proof design valve positioner, it receives from PLC/DCS or other automatic control system instructions such as 4-20mA to work, at the same time feedback the current valve position signal to PLC/DCS and other automatic control system, but also through HART6/7 version of the bus communication.

### 技术特点

- 单键自动整定功能
- 死区精度可设定
- 故障安全位置设定
- 英文菜单设置
- 重复定位精度误差 ≤ 0.2%
- 阀位保持时不耗气
- 可曲线设置
- 本安防爆认证
- IP66 防护等级

### Technical Features

- Single key automatic setting function
- Precision of dead zone can be set
- Failsafe position setting
- English menu setting
- Repeated positioning accuracy error ≤ 0.2%
- No gas consumption when the valve position is maintained
- Curve setting
- Intrinsic safety and explosion proof certification
- IP66 protection grade





# 控制器选型表 Controller selection table

## 阀门定位器-IL-TOP-系列型号定义 Valve Positioner -IL-TOP- Series Model definition

EXD IL-TOP-21A 3 1 31 RS485 A

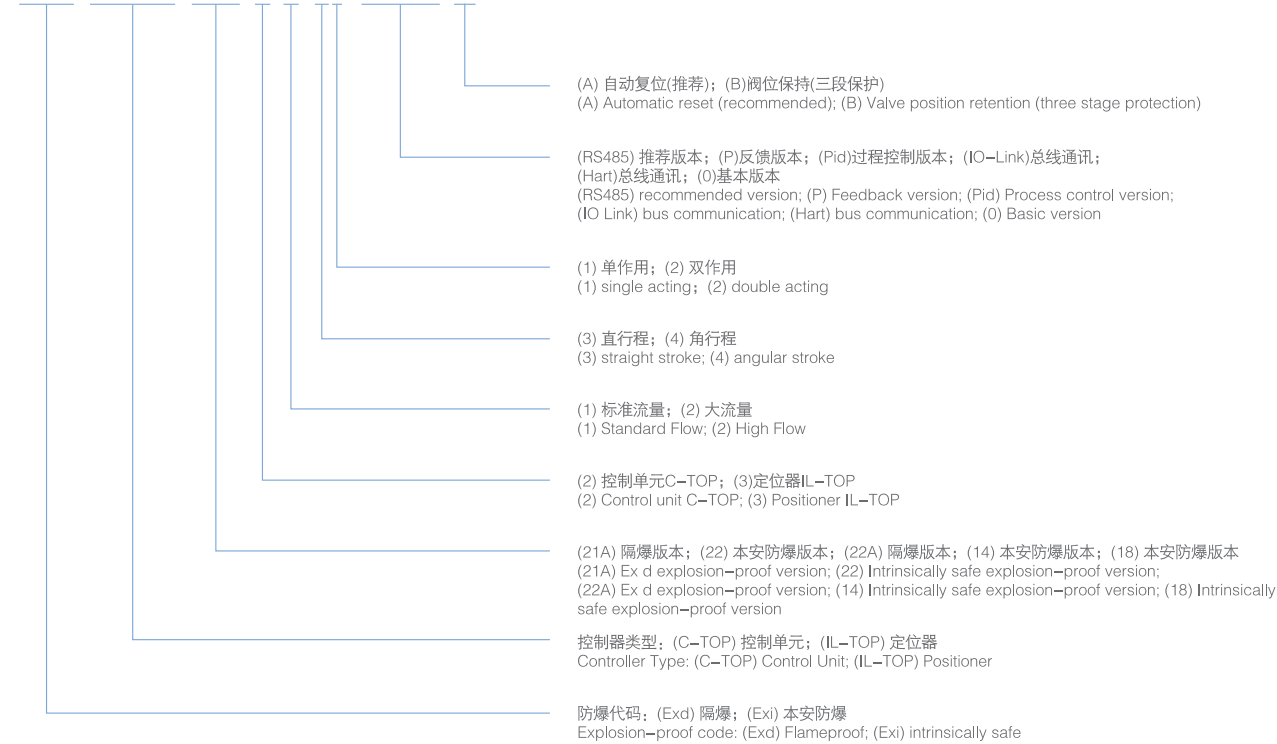

## IL-TOP-21A31/22A32



型号 Model	适用执行器 Applicable actuator	输入信号 Input signal	通讯协议 Communication protocol	输出信号 Output signal	备注 Remarks
标准流量阀门定位器-适用于: ≤ 气缸Φ 114 250mL Standard flow valve positioner-Suitable for: ≤ cylinder Φ 114 250mL					
IL-TOP-21A3131-RS485	单作用Single acting	0/4-20mA, 0-5V/10V	MOD BUS RS485	-	推荐版本 Recommended version
IL-TOP-21A3132-RS485	双作用Double acting	-	-	-	-
IL-TOP-21A3131-IO-link	单作用Single acting	-	IO-Link V1.1	-	选项版本 Option version
IL-TOP-21A3132-IO-link	双作用Double acting	-	-	-	-
IL-TOP-21A3131-P	单作用Single acting	0/4-20mA, 0-5V/10V	-	0/4-20mA, 0-5V/10V	选项版本 Option version
IL-TOP-21A3132-P	双作用Double acting	-	-	-	-
IL-TOP-21A3131-Pid	单作用Single acting	0/4-20mA, 0-5V/10V	-	0/4-20mA, 0-5V/10V	过程控制输入 Process control input 4-20mA/PT100
IL-TOP-21A3132-Pid	双作用Double acting	-	-	-	-
大流量阀门定位器-适用于: ≥ 气缸Φ 114 250mL High flow valve positioner-Suitable for: ≥ cylinder Φ 114 250mL					
IL-TOP-21A3231-RS485	单作用Single acting	0/4-20mA, 0-5V/10V	MOD BUS RS485	-	推荐版本 Recommended version
IL-TOP-21A3232-RS485	双作用Double acting	-	-	-	-
IL-TOP-21A3231-IO-link	单作用Single acting	-	IO-Link V1.1	-	选项版本 Option version
IL-TOP-21A3232-IO-link	双作用Double acting	-	-	-	-
IL-TOP-21A3231-P	单作用Single acting	0/4-20mA, 0-5V/10V	-	0/4-20mA, 0-5V/10V	选项版本 Option version
IL-TOP-21A3232-P	双作用Double acting	-	-	-	-
IL-TOP-21A3231-Pid	单作用Single acting	0/4-20mA, 0-5V/10V	-	0/4-20mA, 0-5V/10V	过程控制输入 Process control input 4-20mA/PT100
IL-TOP-21A3232-Pid	双作用Double acting	-	-	-	-

## IL-TOP-2231/2232



型号 Model	适用执行器 Applicable actuator	输入信号 Input signal	通讯协议 Communication protocol	输出信号 Output signal	备注 Remarks
标准流量阀门定位器-适用于: ≤ 气缸Φ 114 250mL Standard flow valve positioner-Suitable for: ≤ cylinder Φ 114 250mL					
IL-TOP-223131-RS485	单作用Single acting	0/4-20mA, 0-5V/10V	MOD BUS RS485	-	推荐版本 Recommended version
IL-TOP-223132-RS485	双作用Double acting	-	-	-	-
IL-TOP-223131-IO-link	单作用Single acting	-	IO-Link V1.1	-	选项版本 Option version
IL-TOP-223132-IO-link	双作用Double acting	-	-	-	-
IL-TOP-223131-P	单作用Single acting	0/4-20mA, 0-5V/10V	-	0/4-20mA, 0-5V/10V	选项版本 Option version
IL-TOP-223132-P	双作用Double acting	-	-	-	-
IL-TOP-223131-Pid	单作用Single acting	0/4-20mA, 0-5V/10V	-	0/4-20mA, 0-5V/10V	过程控制输入 Process control input 4-20mA/PT100
IL-TOP-223132-Pid	双作用Double acting	-	-	-	-
大流量阀门定位器-适用于: ≥ 气缸Φ 114 250mL High flow valve positioner-Suitable for: ≥ cylinder Φ 114 250mL					
IL-TOP-223231-RS485	单作用Single acting	0/4-20mA, 0-5V/10V	MOD BUS RS485	-	推荐版本 Recommended version
IL-TOP-223232-RS485	双作用Double acting	-	-	-	-
IL-TOP-223231-IO-link	单作用Single acting	-	IO-Link V1.1	-	选项版本 Option version
IL-TOP-223232-IO-link	双作用Double acting	-	-	-	-
IL-TOP-223231-P	单作用Single acting	0/4-20mA, 0-5V/10V	-	0/4-20mA, 0-5V/10V	选项版本 Option version
IL-TOP-223232-P	双作用Double acting	-	-	-	-
IL-TOP-223231-Pid	单作用Single acting	0/4-20mA, 0-5V/10V	-	0/4-20mA, 0-5V/10V	过程控制输入 Process control input 4-20mA/PT100
IL-TOP-223232-Pid	双作用Double acting	-	-	-	-

## IL-TOP-2201/2202



型号 Model	适用执行器 Applicable actuator	输入信号 Input signal	通讯协议 Communication protocol	输出信号 Output signal	备注 Remarks
标准流量阀门定位器-适用于: ≤ 气缸Φ 114 250mL Standard flow valve positioner-Suitable for: ≤ cylinder Φ 114 250mL					
IL-TOP-220131-RS485	单作用Single acting	0/4-20mA, 0-5V/10V	MOD BUS RS485	-	推荐版本 Recommended version
IL-TOP-220132-RS485	双作用Double acting	-	-	-	-
IL-TOP-220131-IO-link	单作用Single acting	-	IO-Link V1.1	-	选项版本 Option version
IL-TOP-220132-IO-link	双作用Double acting	-	-	-	-
IL-TOP-220131-P	单作用Single acting	0/4-20mA, 0-5V/10V	-	0/4-20mA, 0-5V/10V	选项版本 Option version
IL-TOP-220132-P	双作用Double acting	-	-	-	-
IL-TOP-220131-Pid	单作用Single acting	0/4-20mA, 0-5V/10V	-	0/4-20mA, 0-5V/10V	过程控制输入 Process control input 4-20mA/PT100
IL-TOP-220132-Pid	双作用Double acting	-	-	-	-
大流量阀门定位器-适用于: ≥ 气缸Φ 114 250mL High flow valve positioner-Suitable for: ≥ cylinder Φ 114 250mL					
IL-TOP-220231-RS485	单作用Single acting	0/4-20mA, 0-5V/10V	MOD BUS RS485	-	推荐版本 Recommended version
IL-TOP-220232-RS485	双作用Double acting	-	-	-	-
IL-TOP-220231-IO-link	单作用Single acting	-	IO-Link V1.1	-	选项版本 Option version
IL-TOP-220232-IO-link	双作用Double acting	-	-	-	-
IL-TOP-220231-P	单作用Single acting	0/4-20mA, 0-5V/10V	-	0/4-20mA, 0-5V/10V	选项版本 Option version
IL-TOP-220232-P	双作用Double acting	-	-	-	-
IL-TOP-220231-Pid	单作用Single acting	0/4-20mA, 0-5V/10V	-	0/4-20mA, 0-5V/10V	过程控制输入 Process control input 4-20mA/PT100
IL-TOP-220232-Pid	双作用Double acting	-	-	-	-

## IL-TOP-189141/189142

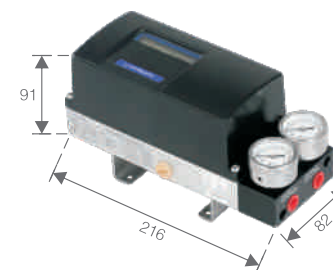

型号 Model	适用执行器 Applicable actuator	输入信号 Input signal	通讯协议 Communication protocol	输出信号 Output signal	备注 Remarks
标准流量阀门定位器-适用于: ≤ 气缸Φ 114 250mL Standard flow valve positioner-Suitable for: ≤ cylinder Φ 114 250mL					
IL-TOP-189141	单作用Single acting	4-20mA	-	-	推荐版本 Recommended version
IL-TOP-189142	双作用Double acting	-	-	-	-
IL-TOP-189141-Hart	单作用Single acting	-	Hart 6/7	-	选项版本 Option version
IL-TOP-189142-Hart	双作用Double acting	-	-	-	-
IL-TOP-189141-P	单作用Single acting	4-20mA	-	4-20mA	选项版本 Option version
IL-TOP-189142-P	双作用Double acting	-	-	-	-



## 控制器选型表 Controller selection table

### IL-TOP-1441/1442

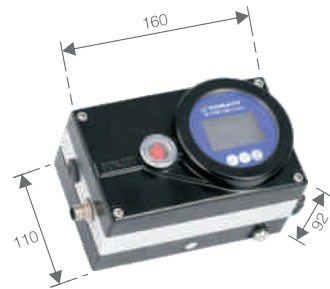

型号 Model	适用执行器 Applicable actuator	输入信号 Input signal	通讯协议 Communication protocol	输出信号 Output signal	备注 Remarks
标准流量阀门定位器-适用于: ≤ 气缸Φ 114 250mL Standard flow valve positioner-Suitable for: ≤ cylinder Φ 114 250mL					
IL-TOP-144141-RS485	单作用Single acting	0/4-20mA, 0-5V/10V	MOD BUS RS485	-	推荐版本 Recommended version
IL-TOP-144142-RS485	双作用Double acting		-	-	选项版本 Option version
IL-TOP-144141-IO-link	单作用Single acting	-	IO-Link V1.1	-	选项版本 Option version
IL-TOP-144142-IO-link	双作用Double acting		-	-	选项版本 Option version
IL-TOP-144141-P	单作用Single acting	0/4-20mA, 0-5V/10V	-	0/4-20mA, 0-5V/10V	选项版本 Option version
IL-TOP-144142-P	双作用Double acting		-	0/4-20mA, 0-5V/10V	过程控制输入 Process control input 4-20mA/PT100
IL-TOP-144141-Pid	单作用Single acting	0/4-20mA, 0-5V/10V	-	0/4-20mA, 0-5V/10V	过程控制输入 Process control input 4-20mA/PT100
IL-TOP-144142-Pid	双作用Double acting		-	0/4-20mA, 0-5V/10V	过程控制输入 Process control input 4-20mA/PT100
大流量阀门定位器-适用于: ≥ 气缸Φ 114 250mL High flow valve positioner-Suitable for: ≥ cylinder Φ 114 250mL					
IL-TOP-144241-RS485	单作用Single acting	0/4-20mA, 0-5V/10V	MOD BUS RS485	-	推荐版本 Recommended version
IL-TOP-144242-RS485	双作用Double acting		-	-	选项版本 Option version
IL-TOP-144241-IO-link	单作用Single acting	-	IO-Link V1.1	-	选项版本 Option version
IL-TOP-144242-IO-link	双作用Double acting		-	-	选项版本 Option version
IL-TOP-144241-P	单作用Single acting	0/4-20mA, 0-5V/10V	-	0/4-20mA, 0-5V/10V	选项版本 Option version
IL-TOP-144242-P	双作用Double acting		-	0/4-20mA, 0-5V/10V	过程控制输入 Process control input 4-20mA/PT100
IL-TOP-144241-Pid	单作用Single acting	0/4-20mA, 0-5V/10V	-	0/4-20mA, 0-5V/10V	过程控制输入 Process control input 4-20mA/PT100
IL-TOP-144242-Pid	双作用Double acting		-	0/4-20mA, 0-5V/10V	过程控制输入 Process control input 4-20mA/PT100

### IL-TOP-22A41/22A42

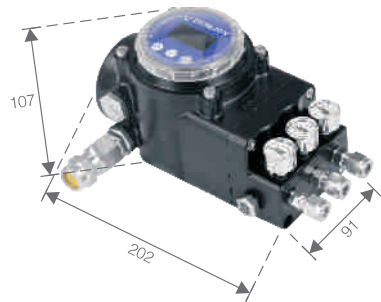

型号 Model	适用执行器 Applicable actuator	输入信号 Input signal	通讯协议 Communication protocol	输出信号 Output signal	备注 Remarks
标准流量阀门定位器-适用于: ≤ 气缸Φ 114 250mL Standard flow valve positioner-Suitable for: ≤ cylinder Φ 114 250mL					
IL-TOP-22A4141-RS485	单作用Single acting	0/4-20mA, 0-5V/10V	MOD BUS RS485	-	推荐版本 Recommended version
IL-TOP-22A4142-RS485	双作用Double acting		-	-	选项版本 Option version
IL-TOP-22A4141-IO-link	单作用Single acting	-	IO-Link V1.1	-	选项版本 Option version
IL-TOP-22A4142-IO-link	双作用Double acting		-	-	选项版本 Option version
IL-TOP-22A4141-P	单作用Single acting	0/4-20mA, 0-5V/10V	-	0/4-20mA, 0-5V/10V	选项版本 Option version
IL-TOP-22A4142-P	双作用Double acting		-	0/4-20mA, 0-5V/10V	过程控制输入 Process control input 4-20mA/PT100
IL-TOP-22A4141-Pid	单作用Single acting	0/4-20mA, 0-5V/10V	-	0/4-20mA, 0-5V/10V	过程控制输入 Process control input 4-20mA/PT100
IL-TOP-22A4142-Pid	双作用Double acting		-	0/4-20mA, 0-5V/10V	过程控制输入 Process control input 4-20mA/PT100
大流量阀门定位器-适用于: ≥ 气缸Φ 114 250mL High flow valve positioner-Suitable for: ≥ cylinder Φ 114 250mL					
IL-TOP-22A4241-RS485	单作用Single acting	0/4-20mA, 0-5V/10V	MOD BUS RS485	-	推荐版本 Recommended version
IL-TOP-22A4242-RS485	双作用Double acting		-	-	选项版本 Option version
IL-TOP-22A4241-IO-link	单作用Single acting	-	IO-Link V1.1	-	选项版本 Option version
IL-TOP-22A4242-IO-link	双作用Double acting		-	-	选项版本 Option version
IL-TOP-22A4241-P	单作用Single acting	0/4-20mA, 0-5V/10V	-	0/4-20mA, 0-5V/10V	选项版本 Option version
IL-TOP-22A4242-P	双作用Double acting		-	0/4-20mA, 0-5V/10V	过程控制输入 Process control input 4-20mA/PT100
IL-TOP-22A4241-Pid	单作用Single acting	0/4-20mA, 0-5V/10V	-	0/4-20mA, 0-5V/10V	过程控制输入 Process control input 4-20mA/PT100
IL-TOP-22A4242-Pid	双作用Double acting		-	0/4-20mA, 0-5V/10V	过程控制输入 Process control input 4-20mA/PT100

## 隔爆系列-阀门控制单元-C-TOP-21A21 Exd flameproof series-Valve Control unit-C-TOP-21A21

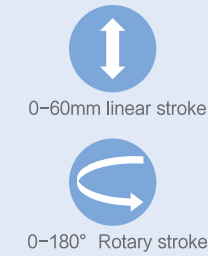

高精度、阀门防泄漏、  
高效率、高洁净、精度可设定  
按钮操作、无需拆卸、隔爆&本安防爆双认证  
High precision, leakage proof valve,  
High efficiency, high cleanliness, precision can be set  
Push-button operation, no disassembly, flameproof & intrinsic safety explosion-proof double certification

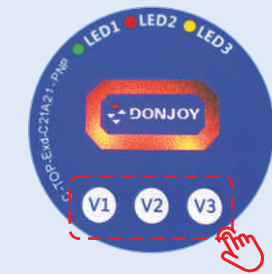

V1+V2按钮5S 启动自动阀位整定  
V1+V3按钮5S进入精度和颜色切换设定模式  
V1+V2 button 5S to start automatic valve setting  
V1+V3 button 5S to enter the setting mode of precision and color switching



C-TOP-21A21是一款隔爆设计的阀门控制单元，它接收来自PLC/DCS或其他自控系统指令进行工作，同时反馈当前阀门位置信号到PLC/DCS等自控系统，也可通过IO-Link、AS-I V3.0版本总线通讯。每个位置都会通过不同位置颜色LED灯显示当前状态。

C-TOP-21A21 is a Ex d explosion-proof valve control unit. It receives instructions from PLC/DCS or other automatic control systems to work, and feedback the current valve position signal to PLC/DCS and other automatic control systems. It can also communicate through IO-Link and AS-I V3.0 version bus. Each location will display its current status through a different location color LED light.

### 技术特点

- 单键自动整定
- 阀门防泄漏功能
- 阀门故障反馈功能
- 不同的阀位显示不同颜色的LED灯
- 信号反馈: PNP NPN 无源触点 4-20mA
- 总线通讯: IO-Link; AS-I V3.0
- 供电: DC24V ± 10%
- 行程: 60mm; 30mm
- 阀位精度可现场设定: 0.2mm, 0.5mm, 1mm, 2mm, 3mm
- 高位和低位颜色可现场设定

### Technical Features

- Single key automatic setting
- Valve anti-leakage function
- Valve fault feedback function
- Different valve positions display different colors of LED lights
- Signal feedback: PNP NPN passive contact 4-20mA
- Bus communication: IO-Link; AS-I V3.0
- Power supply: DC24V ± 10%
- Stroke: 60mm; 30mm
- The precision of valve position can be set on site: 0.2mm, 0.5mm, 1mm, 2mm, 3mm
- High and low color can be set on site

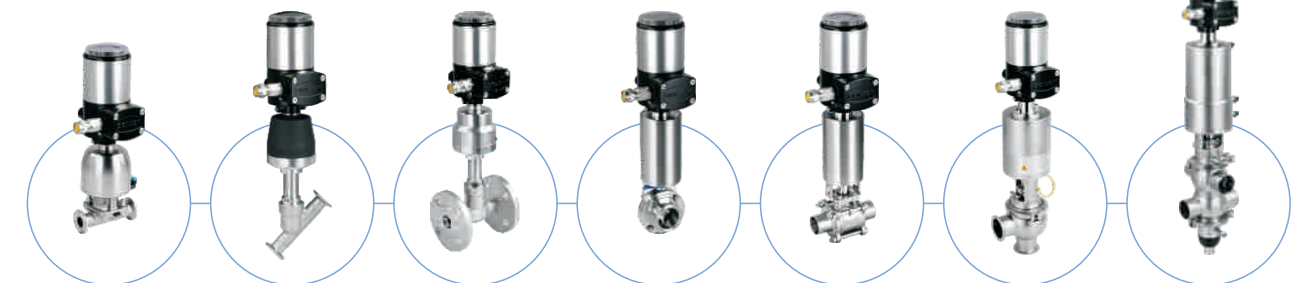

# 本安防爆系列-阀门控制单元-C-TOP-2221 Intrinsically safe explosion-proof series-Valve Control Unit-C-TOP-2221

↑  
0-60mm linear stroke

↻  
0-180° Rotary stroke



高精度、阀门防泄漏、  
高效率、高洁净、精度可设定  
按钮操作、无需拆卸、隔爆&本安防爆双认证

High precision, leakage proof valve,  
High efficiency, high cleanliness, precision can be set  
Push-button operation, no disassembly, flameproof &  
intrinsic safety explosion-proof double certification

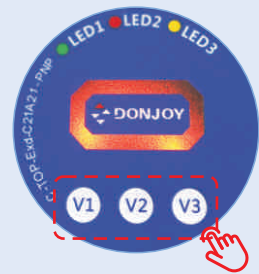

V1+V2按钮5S 启动自动阀位整定  
V1+V3按钮5S进入精度和颜色切换设定模式  
V1+V2 button 5S to start automatic valve setting  
V1+V3 button 5S to enter the setting mode of precision and color switching



C-TOP-2221是一款本安防爆设计的阀门控制单元，它接收来自PLC/DCS或其他自控系统指令进行工作，同时反馈当前阀门位置信号到PLC/DCS等自控系统，也可通过IO-Link、AS-I V3.0版本总线通讯。每个位置都会通过不同位置颜色LED灯显示当前状态。

## 技术特点

- 单键自动整定
- 阀门防泄漏功能
- 阀门故障反馈功能
- 不同的阀位显示不同颜色的LED灯
- 信号反馈: PNP NPN 无源触点 4-20mA
- 总线通讯: IO-Link; AS-I V3.0
- 供电: DC24V ± 10%
- 行程: 60mm; 30mm
- 阀位精度可现场设定: 0.2mm, 0.5mm, 1mm, 2mm, 3mm
- 高位和低位颜色可现场设定



# 本安防爆系列-阀门控制单元-C-TOP-2211 Intrinsically safe explosion-proof series-Valve Control Unit-C-TOP-2211

↑  
0-45mm linear stroke



高精度、阀门防泄漏、  
高效率、高洁净、精度可设定  
按钮操作、无需拆卸、隔爆&本安防爆双认证

High precision, leakage proof valve,  
High efficiency, high cleanliness, precision can be set  
Push-button operation, no disassembly, flameproof &  
intrinsic safety explosion-proof double certification

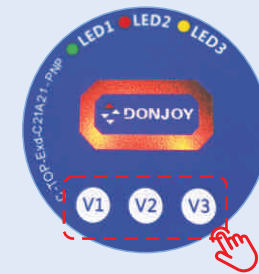

V1+V2按钮5S 启动自动阀位整定  
V1+V3按钮5S进入精度和颜色切换设定模式  
V1+V2 button 5S to start automatic valve setting  
V1+V3 button 5S to enter the setting mode of precision and color switching



C-TOP-2211是一款本安防爆设计的阀门控制单元，它接收来自PLC/DCS或其他自控系统指令进行工作，同时反馈当前阀门位置信号到PLC/DCS等自控系统，也可通过IO-Link、AS-I V3.0版本总线通讯。每个位置都会通过不同位置颜色LED灯显示当前状态。

## 技术特点

- 单键自动整定
- 阀门防泄漏功能
- 阀门故障反馈功能
- 不同的阀位显示不同颜色的LED灯
- 信号反馈: PNP NPN 无源触点 4-20mA
- 总线通讯: IO-Link; AS-I V3.0
- 供电: DC24V ± 10%
- 行程: 45mm; 30mm
- 阀位精度可现场设定: 0.2mm, 0.5mm, 1mm, 2mm, 3mm
- 高位和低位颜色可现场设定

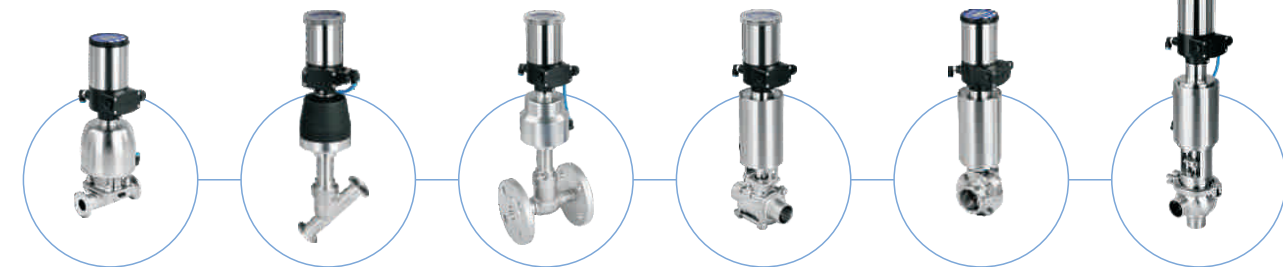



## 本安防爆系列-阀门控制单元-C-TOP-2262 Intrinsic safety explosion-proof series - Valve Control Unit-C-TOP-2262



高精度、阀门防泄漏、  
高效率、高洁净、精度可设定  
按钮操作、无需拆卸、隔爆&本安防爆双认证

High precision, leakage proof valve,  
High efficiency, high cleanliness, precision can be set  
Push-button operation, no disassembly, flameproof & intrinsic safety explosion-proof double certification



⚠ 短按一次进入手动模式，  
短按V则开启电磁阀(谨慎使用)  
Press once to enter manual mode,  
press V to open solenoid valve  
(use with caution)

V+ 按钮5S 启动自动阀位整定  
短按 8次进入精度和颜色切换设定模式  
V+ 按钮 5S to start automatic valve setting  
Press 8 times to enter the precision and color toggle setting mode



C-TOP-2262是一款本安防爆设计的阀门控制单元，它接收来自PLC/DCS或其他自控系统指令进行工作，同时反馈当前阀门位置信号到PLC/DCS等自控系统，也可通过IO-Link、AS-I V3.0版本总线通讯。每个位置都会通过不同位置颜色LED灯显示当前状态。

C-TOP-2262 is an intrinsically safe explosion-proof design of the valve control unit, it receives from PLC/DCS or other automatic control system instructions to work, at the same time feedback the current valve position signal to PLC/DCS and other automatic control system, but also through the IO-Link, AS-I V3.0 version of the bus communication. Each location will display its current status through a different location color LED light.

### 技术特点

- 单键自动整定
- 阀门防泄漏功能
- 阀门故障反馈功能
- 不同的阀位显示不同颜色的LED灯
- 信号反馈: PNP NPN 无源触点 4-20mA
- 总线通讯: IO-Link; AS-I V3.0
- 供电: DC24V ± 10%
- 旋转行程: 0-180°
- 阀位精度可现场设定: ±0.2°, ±0.5°, ±1°, ±1.5°
- 高位和低位颜色可现场设定

### Technical Features

- Single key automatic setting
- Valve anti-leakage function
- Valve fault feedback function
- Different valve positions display different colors of LED lights
- Signal feedback: PNP NPN passive contact 4-20mA
- Bus communication: IO-Link; AS-I V3.0
- Power supply: DC24V ± 10%
- Rotation distance: 0-180°
- The precision of valve position can be set on site: ±0.2°, ±0.5°, ±1°, ±1.5°
- High and low color can be set on site



## 隔爆系列-阀门控制单元-C-TOP-22A62 Exd flameproof series-Valve Control unit-C-TOP-22A62



高精度、阀门防泄漏、  
高效率、高洁净、精度可设定  
按钮操作、无需拆卸、隔爆&本安防爆双认证

High precision, leakage proof valve,  
High efficiency, high cleanliness, precision can be set  
Push-button operation, no disassembly, flameproof & intrinsic safety explosion-proof double certification

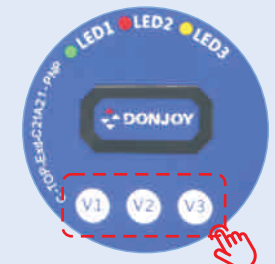

V1+V2按钮5S 启动自动阀位整定  
V1+V3按钮5S进入精度和颜色切换设定模式  
V1+V2 button 5S to start automatic valve setting  
V1+V3 button 5S to enter the setting mode of precision and color switching



C-TOP-22A62是一款隔爆设计的阀门控制单元，它接收来自PLC/DCS或其他自控系统指令进行工作，同时反馈当前阀门位置信号到PLC/DCS等自控系统，也可通过IO-Link、AS-I V3.0版本总线通讯。每个位置都会通过不同位置颜色LED灯显示当前状态。

C-TOP-22A62 is an Ex d explosionproof valve control unit. It receives instructions from PLC/DCS or other automatic control systems to work, and feeds back the current valve position signal to PLC/DCS and other automatic control systems. It can also communicate through IO-Link and AS-I V3.0 version bus. Each location will display its current status through a different location color LED light.

### 技术特点

- 单键自动整定
- 阀门防泄漏功能
- 阀门故障反馈功能
- 不同的阀位显示不同颜色的LED灯
- 信号反馈: PNP NPN 无源触点 4-20mA
- 总线通讯: IO-Link; AS-I V3.0
- 供电: DC24V ± 10%
- 旋转行程: 0-180°
- 阀位精度可现场设定: ±0.2°, ±0.5°, ±1°, ±1.5°
- 高位和低位颜色可现场设定

### Technical Features

- Single key automatic setting
- Valve anti-leakage function
- Valve fault feedback function
- Different valve positions display different colors of LED lights
- Signal feedback: PNP NPN passive contact 4-20mA
- Bus communication: IO-Link; AS-I V3.0
- Power supply: DC24V ± 10%
- Rotation distance: 0-180°
- The precision of valve position can be set on site: ±0.2°, ±0.5°, ±1°, ±1.5°
- High and low color can be set on site

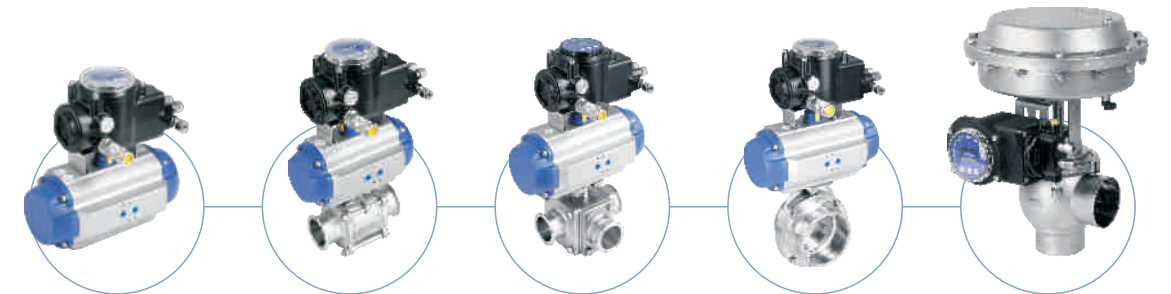

# 控制器选型表 Controller selection table

## 阀门控制单元-C-TOP-系列型号定义 Valve Control Unit -C-TOP- Series Model definition

EXD C-TOP-21A 2 1 31 AS-I

(IO-link) 总线通讯协议IO-Link V1.1; (AS-I)总线通讯协议 AS-I V3.0  
(IO link) bus communication protocol IO Link V1.1; (AS-I) bus communication protocol AS-I V3.0

(1) 单作用; (2) 双作用; (3) 三作用  
(1) single acting; (2) double acting; (3) Three acting

(3) 直行程; (4) 角行程  
(3) straight stroke; (4) angular stroke

(1) 标准流量  
(1) Standard Flow

(1) 迷你型控制单元C-TOP; (2) 标准型控制单元C-TOP  
(1) Mini control unit C-TOP; (2) Standard control unit C-TOP

(21A) 隔爆版本; (22) 本安防爆版本; (22A) 隔爆版本 (17) 本安防爆版本  
(21A) Ex d explosion-proof version; (22) Intrinsically safe explosion-proof version;  
(22A) Ex d explosion-proof version; (17) Intrinsically safe explosion-proof version

控制器类型: (C-TOP) 控制单元; (IL-TOP) 定位器  
Controller Type: (C-TOP) Control Unit; (IL-TOP) Positioner

防爆代码: (Exd) 隔爆; (Exi) 本安防爆  
Explosion-proof code: Ex d explosion-proof; (Exi) intrinsically safe

### Exd-C-TOP-21A21



型号 Model	适用执行器 Applicable actuator	输出信号 Output signal	供电 Power supply	输出阀位信号 Output valve position signal	输入信号 Input signal
C-TOP-21A2131-PNP	单作用Single acting	PNP	DC24V	2	PNP DC24V
C-TOP-21A2132-PNP	双作用Double acting			3	
C-TOP-21A2133-PNP	三作用Three acting			3	
C-TOP-21A2131-DCS	单作用Single acting	干节点Dry contact	DC24V	2	PNP DC24V
C-TOP-21A2132-DCS	双作用Double acting			3	
C-TOP-21A2133-DCS	三作用Three acting			3	
C-TOP-21A2131-IO-Link	单作用Single acting	IO-Link V1.1	DC24V	2	PNP DC24V
C-TOP-21A2132-IO-Link	双作用Double acting			3	
C-TOP-21A2133-IO-Link	三作用Three acting			3	
C-TOP-21A2131-AS-I	单作用Single acting	AS-I V3.0	DC30V	2	PNP DC24V
C-TOP-21A2132-AS-I	双作用Double acting			3	
C-TOP-21A2133-AS-I	三作用Three acting			3	

### Exi-C-TOP-2221



型号 Model	适用执行器 Applicable actuator	输出信号 Output signal	供电 Power supply	输出阀位信号 Output valve position signal	输入信号 Input signal
C-TOP-222131-PNP	单作用Single acting	PNP	DC24V	2	PNP DC24V
C-TOP-222132-PNP	双作用Double acting			3	
C-TOP-222133-PNP	三作用Three acting			3	
C-TOP-222131-DCS	单作用Single acting	干节点Dry contact	DC24V	2	PNP DC24V
C-TOP-222132-DCS	双作用Double acting			3	
C-TOP-222133-DCS	三作用Three acting			3	
C-TOP-222131-IO-Link	单作用Single acting	IO-Link V1.1	DC24V	2	PNP DC24V
C-TOP-222132-IO-Link	双作用Double acting			3	
C-TOP-222133-IO-Link	三作用Three acting			3	
C-TOP-222131-AS-I	单作用Single acting	AS-I V3.0	DC30V	2	PNP DC24V
C-TOP-222132-AS-I	双作用Double acting			3	
C-TOP-222133-AS-I	三作用Three acting			3	

### Exi-C-TOP-2211 (Mini型)



型号 Model	适用执行器 Applicable actuator	输出信号 Output signal	供电 Power supply	输出阀位信号 Output valve position signal	输入信号 Input signal
C-TOP-221131-PNP	单作用Single acting	PNP	DC24V	2	PNP DC24V
C-TOP-221132-PNP	双作用Double acting			2	
C-TOP-221133-PNP	三作用Three acting			2	
C-TOP-221131-DCS	单作用Single acting	干节点Dry contact	DC24V	2	PNP DC24V
C-TOP-221132-DCS	双作用Double acting			2	
C-TOP-221133-DCS	三作用Three acting			2	
C-TOP-221131-IO-Link	单作用Single acting	IO-Link V1.1	DC24V	2	PNP DC24V
C-TOP-221132-IO-Link	双作用Double acting			2	
C-TOP-221133-IO-Link	三作用Three acting			2	
C-TOP-221131-AS-I	单作用Single acting	AS-I V3.0	DC30V	2	PNP DC24V
C-TOP-221132-AS-I	双作用Double acting			2	
C-TOP-221133-AS-I	三作用Three acting			2	

### Exi-C-TOP-2262



型号 Model	适用执行器 Applicable actuator	输出信号 Output signal	供电 Power supply	输出阀位信号 Output valve position signal	输入信号 Input signal
C-TOP-226241-PNP	单作用Single acting	PNP	DC24V	2	PNP DC24V
C-TOP-226242-PNP	双作用Double acting			2	
C-TOP-226243-PNP	三作用Three acting			2	
C-TOP-226241-DCS	单作用Single acting	干节点Dry contact	DC24V	2	PNP DC24V
C-TOP-226242-DCS	双作用Double acting			2	
C-TOP-226243-DCS	三作用Three acting			2	
C-TOP-226241-IO-Link	单作用Single acting	IO-Link V1.1	DC24V	2	PNP DC24V
C-TOP-226242-IO-Link	双作用Double acting			2	
C-TOP-226243-IO-Link	三作用Three acting			2	
C-TOP-226241-AS-I	单作用Single acting	AS-I V3.0	DC30V	2	PNP DC24V
C-TOP-226242-AS-I	双作用Double acting			2	
C-TOP-226243-AS-I	三作用Three acting			2	

### Exd-C-TOP-22A62



型号 Model	适用执行器 Applicable actuator	输出信号 Output signal	供电 Power supply	输出阀位信号 Output valve position signal	输入信号 Input signal
C-TOP-22A6241-PNP	单作用Single acting	PNP	DC24V	2	PNP DC24V
C-TOP-22A6242-PNP	双作用Double acting			2	
C-TOP-22A6243-PNP	三作用Three acting			2	
C-TOP-22A6241-DCS	单作用Single acting	干节点Dry contact	DC24V	2	PNP DC24V
C-TOP-22A6242-DCS	双作用Double acting			2	
C-TOP-22A6243-DCS	三作用Three acting			2	
C-TOP-22A6241-IO-Link	单作用Single acting	IO-Link V1.1	DC24V	2	PNP DC24V
C-TOP-22A6242-IO-Link	双作用Double acting			2	
C-TOP-22A6243-IO-Link	三作用Three acting			2	
C-TOP-22A6241-AS-I	单作用Single acting	AS-I V3.0	DC30V	2	PNP DC24V
C-TOP-22A6242-AS-I	双作用Double acting			2	
C-TOP-22A6243-AS-I	三作用Three acting			2	



## 隔爆系列-阀门位置反馈器-F-TOP-22A74 Exd flameproof series-Valve position feedback-F-TOP-22A74



高精度、阀门防泄漏、  
高效率、高洁净、精度可设定  
按钮操作、无需拆卸、隔爆&本安防爆双认证  
High precision, leakage proof valve,  
High efficiency, high cleanliness, precision can be set  
Push-button operation, no disassembly, Ex d explosion-proof  
& intrinsic safety explosion-proof double certification

按钮8S启动 自动阀位整定  
短按8次后进入精度和颜色切换设定模式  
Button 8S to start automatic valve position setting  
Press 8 times to enter the precision and color switching mode



F-TOP-22A74是一款隔爆设计的阀门位置反馈器，它具有不同颜色LED灯显示当前的阀位状态，同时反馈当前阀位信号到各种自控系统其包含PLC/DCS等。

F-TOP-22A74 is a flation-proof valve position feedback device. It has different color LED lights to display the current valve position state, and feed back the current valve position signal to various automatic control systems including PLC/DCS.

### 技术特点

- 单键自动整定
- 不同的阀位显示不同颜色的LED灯
- 高位和低位颜色可现场设定
- 总线通讯: IO-Link; AS-I-V3.0
- 信号反馈: PNP NPN 无源触点 4-20mA
- 供电: DC24V.....DC8V
- 旋转行程: 0-180°
- 阀位精度可现场设定: 0.2mm, 0.5mm, 1mm, 2mm, 3mm
- 防护等级: IP67

### Technical Features

- Single key automatic setting
- Different valve positions display different colors of LED lights
- High and low color can be set on site
- Bus communication: IO-Link; The AS-I-V3.0
- Signal feedback: PNP NPN dry contact 4-20mA
- Power supply: DC24V..... DC8V
- Rotation stroke: 0-180°
- The precision of valve position can be set on site: 0.2mm, 0.5mm, 1mm, 2mm, 3mm
- Protection level: Ip67

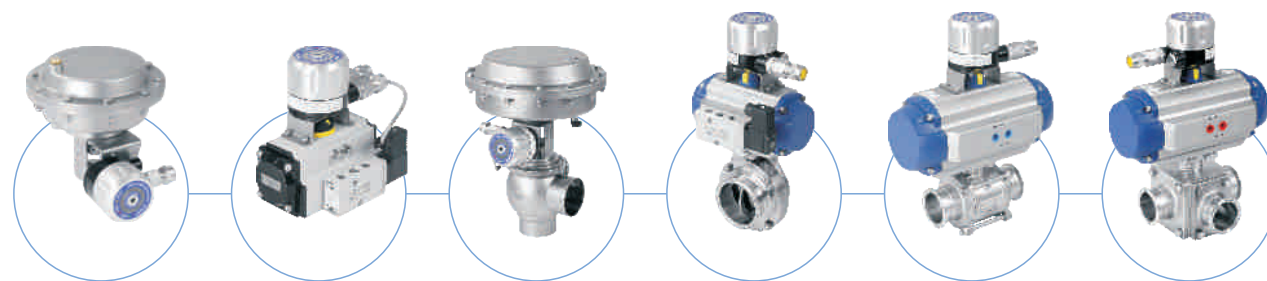

## 隔爆系列-阀门位置反馈器-F-TOP-22A53 Exd flameproof series-Valve position feedback-F-TOP-22A53



高精度、阀门防泄漏、  
高效率、高洁净、精度可设定  
按钮操作、无需拆卸、隔爆&本安防爆双认证  
High precision, leakage proof valve,  
High efficiency, high cleanliness, precision can be set  
Push-button operation, no disassembly, Ex d explosion-proof  
& intrinsic safety explosion-proof double certification

按钮8S启动 自动阀位整定  
短按8次后进入精度和颜色切换设定模式  
Button 8S to start automatic valve position setting  
Press 8 times to enter the precision and color switching mode



F-TOP-22A53是一款隔爆设计的阀门位置反馈器，它具有不同颜色LED灯显示当前的阀位状态，同时反馈当前阀位信号到各种自控系统其包含PLC/DCS等。

F-TOP-22A53 is a flation-proof valve position feedback device, it has different colors of LED lights to display the current valve position state, at the same time feed back the current valve position signal to a variety of automatic control system including PLC/DCS.

### 技术特点

- 单键自动整定
- 阀门防泄漏功能
- 阀门故障反馈功能
- 不同的阀位显示不同颜色的LED灯
- 信号反馈: PNP NPN 无源触点 4-20mA
- 总线通讯: IO-Link; AS-I V3.0
- 供电: DC24V.....DC8V
- 行程: 60mm; 30mm
- 阀位精度可现场设定: 0.2mm, 0.5mm, 1mm, 2mm, 3mm
- 高位和低位颜色可现场设定
- 防护等级: IP67

### Technical Features

- Single key automatic setting
- Valve anti-leakage function
- Valve fault feedback function
- Different valve positions display different colors of LED lights
- Signal feedback: PNP NPN dry contact 4-20mA
- Bus communication: IO-Link; AS-I V3.0
- Power supply: DC24V..... DC8V
- Stroke: 60mm; 30mm
- The precision of valve position can be set on site: 0.2mm, 0.5mm, 1mm, 2mm, 3mm
- High and low color can be set on site
- Protection level: Ip67



# 本安防爆系列-阀门位置反馈器-F-TOP-2253 Intrinsic safety explosion-proof series-Valve position feedback -F-TOP-2253



高精度、阀门防泄漏、  
高效率、高洁净、精度可设定  
按钮操作、无需拆卸、本安防爆认证

High precision, leakage proof valve,  
High efficiency, high cleanliness, precision can be set  
Push-button operation, no disassembly,  
intrinsic safety explosion-proof certificate

按钮8S启动 自动阀位整定  
短按8次后进入精度和颜色切换设定模式  
Button 8S to start automatic valve position setting  
Press 8 times to enter the precision and color switching mode



F-TOP-2253是一款本安防爆设计的阀门位置反馈器，它具有不同颜色LED灯显示当前的阀位状态，同时反馈当前阀位信号到各种自控系统其包含PLC/DCS等。

F-TOP-2253 is an intrinsically safe and explosion-proof design valve position feedback device, it has different colors of LED lights to display the current valve position state, and feed back the current valve position signal to various automatic control systems including PLC/DCS.

## 技术特点

- 单键自动整定
- 阀门防泄漏功能
- 阀门故障反馈功能
- 不同的阀位显示不同颜色的LED灯
- 信号反馈: PNP NPN 无源触点 4-20mA
- 总线通讯: IO-Link; AS-I V3.0
- 供电: DC24V.....DC8V
- 行程: 60mm; 30mm
- 阀位精度可现场设定: 0.2mm, 0.5mm, 1mm, 2mm, 3mm
- 高位和低位颜色可现场设定
- 防护等级: IP68

## Technical Features

- Single key automatic setting
- Valve anti-leakage function
- Valve fault feedback function
- Different valve positions display different colors of LED lights
- Signal feedback: PNP NPN dry contact 4-20mA
- Bus communication: IO-Link; AS-I V3.0
- Power supply: DC24V..... DC8V
- Stroke: 60mm; 30mm
- The precision of valve position can be set on site: 0.2mm, 0.5mm, 1mm, 2mm, 3mm
- High and low color can be set on site
- Protection level: Ip68



# 控制器选型表 Controller selection table

## F-TOP-2253



型号 Model	输出信号类型 Output signal type	供电 Power supply	输出阀位 Output valve position
F-TOP-2253-PNP	PNP	DC24V	3
F-TOP-2253-DCS	干节点Dry contact	DC24V	3
F-TOP-2253-IO-Link	IO-Link V1.1	DC24V	3
F-TOP-2253-AS-I	AS-I V3.0	DC30V	3

## F-TOP-22A53



型号 Model	输出信号类型 Output signal type	供电 Power supply	输出阀位 Output valve position
F-TOP-22A53-PNP	PNP	DC24V	3
F-TOP-22A53-DCS	干节点Dry contact	DC24V	3
F-TOP-22A53-IO-Link	IO-Link V1.1	DC24V	3
F-TOP-22A53-AS-I	AS-I V3.0	DC30V	3

## F-TOP-22A74



型号 Model	输出信号类型 Output signal type	供电 Power supply	输出阀位 Output valve position
F-TOP-22A74-PNP	PNP	DC24V	3
F-TOP-22A74-DCS	干节点Dry contact	DC24V	3
F-TOP-22A74-IO-Link	IO-Link V1.1	DC24V	3
F-TOP-22A74-AS-I	AS-I V3.0	DC30V	3



## 分体式+直行程阀门定位器 Split+straight stroke valve positioner

IL-TOP1441/1442+J-TOP-23A3



### 应用

外置检测单元-阀门定位器，主要为解决因安装空间或现场工况较为恶劣的一种解决方案。该控制器与标准的阀门定位器具有完全相同的功能，外置检测单元具有IP67防护等级，电缆长度可达 $\leq 200\text{M}$ ，阀门控制器可安装用户所需的控制柜等区域对其进行控制。

### Application

External detection unit – valve positioner, mainly to solve the problem of installation space and bad site working conditions. The controller has exactly the same function as the standard valve positioner. The external detection unit has IP67 protection grade and the cable length can be up to  $\leq 200\text{M}$ . The valve controller can be installed in the control cabinet and other areas required by the user to control it.



## 分体式+直行程阀门控制单元 Split+straight stroke valve control unit

C-TOP-2221/21A21+J-TOP-23A3



### 应用

外置检测单元-阀门控制单元，主要为解决因安装空间或现场工况较为恶劣的一种解决方案。该控制器与标准的阀门控制单元具有完全相同的功能，外置检测单元具有IP67防护等级，电缆长度可达 $\leq 200\text{M}$ ，阀门控制单元可安装用户所需的控制柜等区域对其进行控制。

### Application

External testing unit – valve control unit, mainly to solve the problem of installation space and bad site working conditions. The controller has exactly the same function as the standard valve control unit. The external detection unit has IP67 protection grade, and the cable length can be up to  $\leq 200\text{M}$ . The valve control unit can be installed in the control cabinet and other areas required by users to control it.



分体式+旋转行程阀门定位器  
Split+rotary stroke valve positioner

IL-TOP1441/1442+J-TOP-23B4



分体式+旋转行程阀门控制单元  
Split+rotary stroke valve control unit

C-TOP-2262/22A62+J-TOP-23B4



应用

外置检测单元-阀门定位器，主要为解决因安装空间或现场工况较为恶劣的一种解决方案。该控制器与标准的阀门定位器具有完全相同的功能，外置检测单元具有IP67防护等级，电缆长度可达 $\leq 200M$ ，阀门控制器可安装用户所需的控制柜等区域对其进行控制。

Application

External detection unit – valve positioner, mainly to solve the problem of installation space and bad site working conditions. The controller has exactly the same function as the standard valve positioner. The external detection unit has IP67 protection grade and the cable length can be up to  $\leq 200M$ . The valve controller can be installed in the control cabinet and other areas required by the user to control it.



应用

外置检测单元-阀门控制单元，主要为解决因安装空间或现场工况较为恶劣的一种解决方案。该控制器与标准的阀门控制单元具有完全相同的功能，外置检测单元具有IP67防护等级，电缆长度可达 $\leq 200M$ ，阀门控制单元可安装用户所需的控制柜等区域对其进行控制。

Application

External testing unit – valve control unit, mainly to solve the problem of installation space and bad site working conditions. The controller has exactly the same function as the standard valve control unit. The external detection unit has IP67 protection grade, and the cable length can be up to  $\leq 200M$ . The valve control unit can be installed in the control cabinet and other areas required by users to control it.





## 外置直行程检测器-J-TOP-23A3 External straight travel detector-J-TOP-23A3

## 外置旋转行程检测器-J-TOP-23B4 External rotary stroke detector-J-TOP-23B4



外置检测单元适配于DONJOY阀门定位器、阀门控制单元等各种控制器上，它具有安装非常的简单、高效、无需专业人员即可实现。

The external detector is adapted to Donjoy valve positioner, valve control unit etc. It's simple, efficient installation, no need professional personnel.



外置检测单元适配于DONJOY阀门定位器、阀门控制单元等各种控制器上，它具有安装非常的简单、高效、无需专业人员即可实现。

The external detector is adapted to Donjoy valve positioner, valve control unit etc. It's simple, efficient installation, no need professional personnel.

### J-TOP-23A3



### J-TOP-23B4



## 旋转行程阀门控制器与执行器连接 Rotary stroke valve controller is connected to the actuator

适配于各种执行器与阀门  
Suitable for various actuators and valves

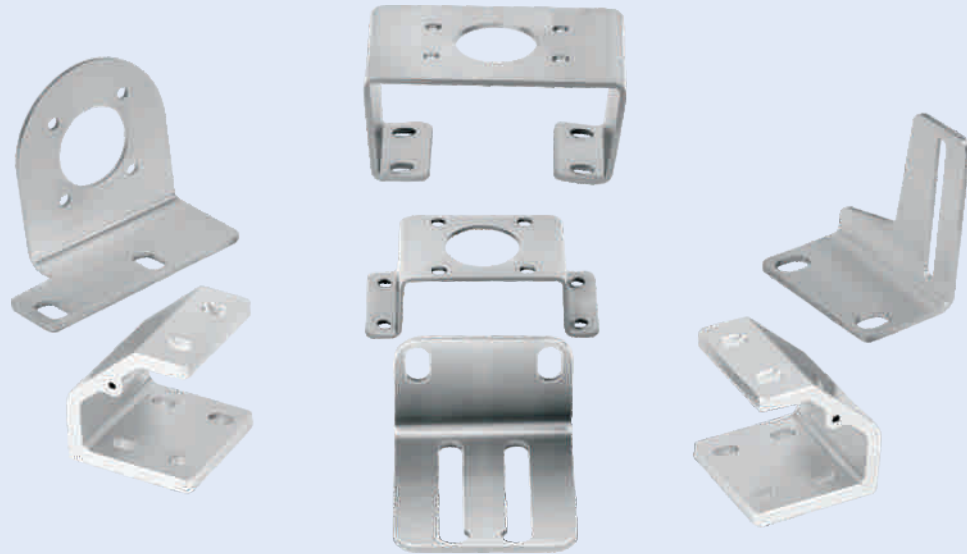

支架适配于各种卧式气动执行器、薄膜式气动执行器，同时适配于阀门控制器IL-TOP、C-TOP、F-TOP、J-TOP等系列。旋转行程阀门控制器设计有弹性补偿伸缩6mm，因此减少了不同规格或不同品牌的执行器而产生的不同安装高度，而需要不同高度的支架才能适配。

The support is suitable for various horizontal pneumatic actuators, film pneumatic actuators, and valve controller IL-TOP, C-TOP, F-TOP, J-TOP series. The rotary stroke valve controller is designed with elastic compensation expansion of 6 mm, so it reduces the different installation heights generated by different specifications or different brands of actuators, and the need for different heights of support to adapt.

### 薄膜气动执行器-侧面安装支架组件 Thin film pneumatic actuator - Side mount bracket assembly

VBM42-150-0001-45

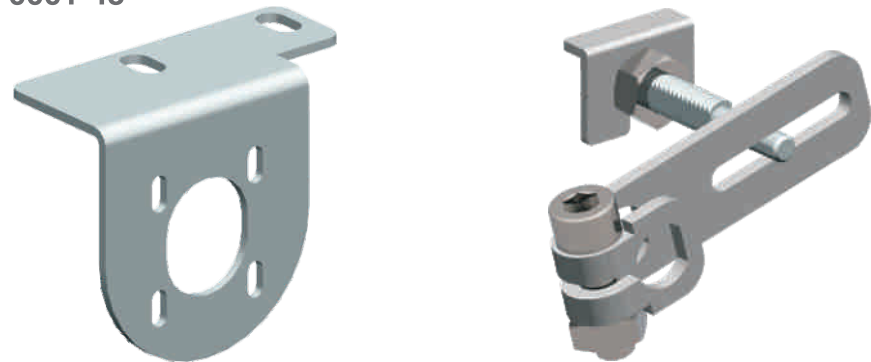

### 薄膜气动执行器+适配各种阀门控制器 Film pneumatic actuator + suitable for various valve controllers

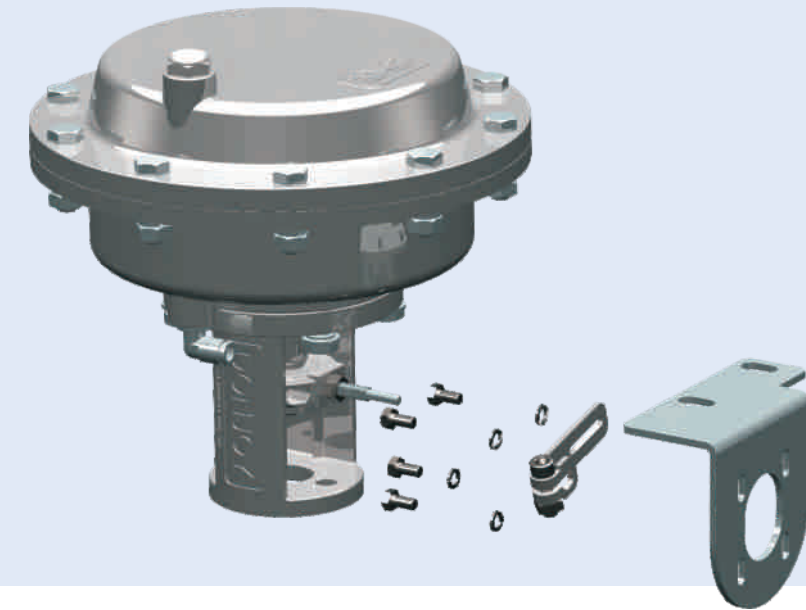

简单、高效、无需专业人员即可完成安装。

因我司旋转式阀门控制器设计有伸缩弹性补偿6mm，因此采用一种规格安装支架即可实现各种执行器安装高度。

Simple, efficient and complete installation without professional personnel.

Because our rotary valve controller design has a telescopic elastic compensation of 6mm, so the installation bracket can be used to achieve a variety of actuator installation height.





## 旋转行程阀门控制器与执行器连接 Rotary stroke valve controller is connected to the actuator

### 卧式气动执行器+适配各种阀门控制器 Horizontal pneumatic actuator + suitable for various valve controllers

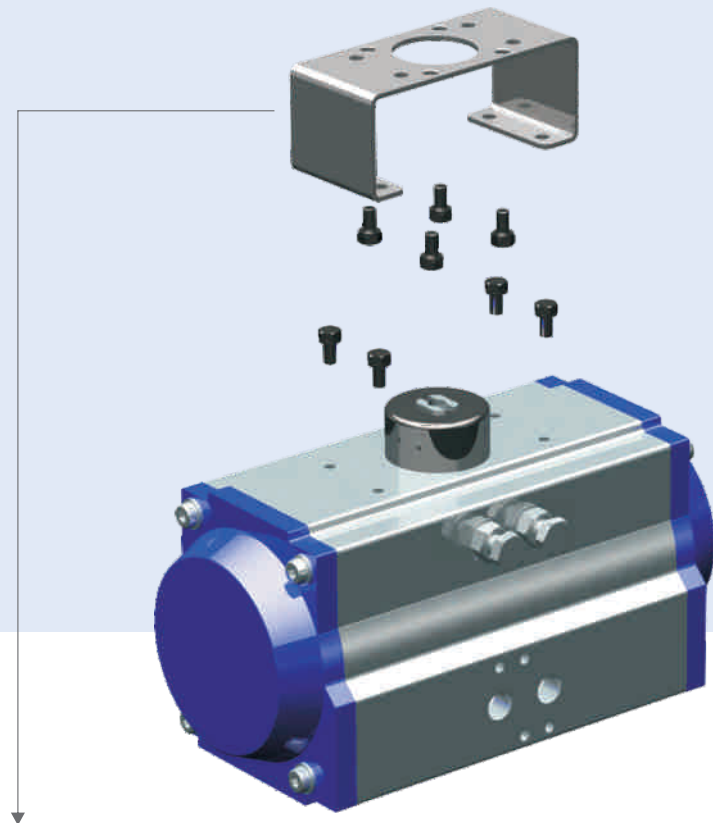

简单、高效、无需专业人员即可完成安装。

因我司旋转式阀门控制器设计有伸缩弹性补偿6mm，因此采用一种规格安装支架即可实现各种执行器安装高度。

Simple, efficient and complete installation without professional personnel.

Because our rotary valve controller design has a telescopic elastic compensation of 6mm, so the installation bracket can be used to achieve a variety of actuator installation height.

因设计了弹性轴向伸缩，一个支架可适配于各种规格卧式气动执行器，且简单高效的安装方式。

Because of the design of elastic axial expansion, a support can be adapted to various specifications of horizontal pneumatic actuators, and simple and efficient installation.



### 立式气动执行器+适配各种阀门控制器 Vertical pneumatic actuator + ADAPTS various valve controllers



极简安装、高效、无需专业人员即可完成安装。

因我司直行程阀门控制器设计弹性伸缩式，而功能设计有单键自动整定位置功能，因此无需考虑对应阀门位置关系即可高效完成。



Simple installation, efficient, complete installation without professional personnel.

Because our direct travel valve controller is designed with elastic retractable type, and the function design has the function of single key automatic setting position, so it can be completed efficiently without considering the corresponding valve position relationship.



# 旋转行程阀门控制器与执行器连接

## Rotary stroke valve controller is connected to the actuator

### 旋转阀门控制器-通用性

#### Rotary Valve controller - universal

轴向弹性伸缩式其主要为解决因执行器不同规格、不同品牌而导致安装高度不同，且产生不同高度支架或连接适配器。而弹性伸缩的出现只需一个规格高度支架即可适配不同品牌及规格的执行器，提高了安装效率、减少了支架和适配器的规格与库存。

The axial elastic retractable type is mainly to solve the problem that the installation height is different due to different specifications and different brands of the actuator, and the different height bracket or connection adapter is produced. The emergence of elastic telescopic only one specification height bracket can be adapted to different brands and specifications of the actuator, improve the installation efficiency, reduce the bracket and adapter specifications and inventory.

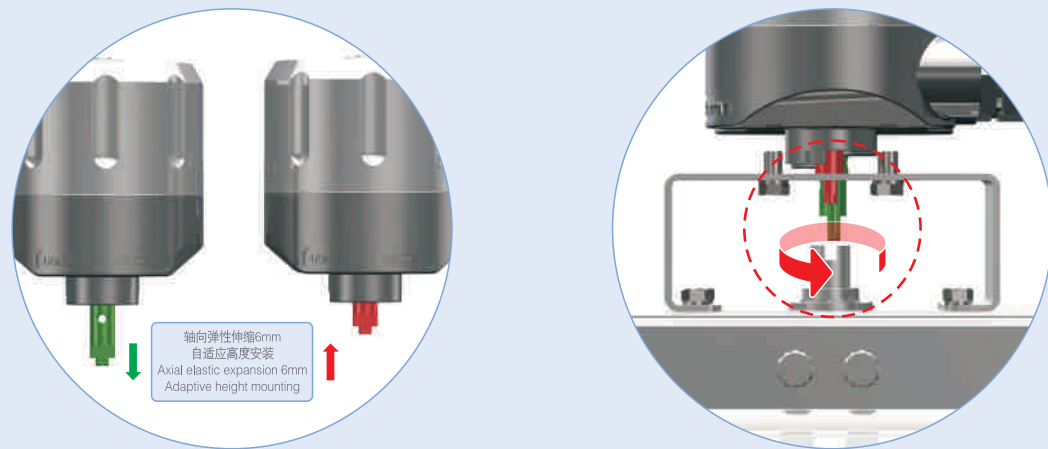

### 直行程阀门控制器-通用性

#### Linear motion valve controller - universal

直行程阀门控制器，具有非常强的通用性它可以适配到各种直行程的气动阀门顶部，如隔膜阀、角座阀、截止阀、换向阀、防混阀、立式气动蝶阀、立式气动球阀等各种气动阀门。

Linear motion valve controller, has a very strong versatility it can be adapted to all kinds of direct travel pneumatic valve top, such as diaphragm valve, Angle valve, globe valve, reversing valve, anti-mixing valve, vertical pneumatic butterfly valve, vertical pneumatic ball valve and other pneumatic valves.

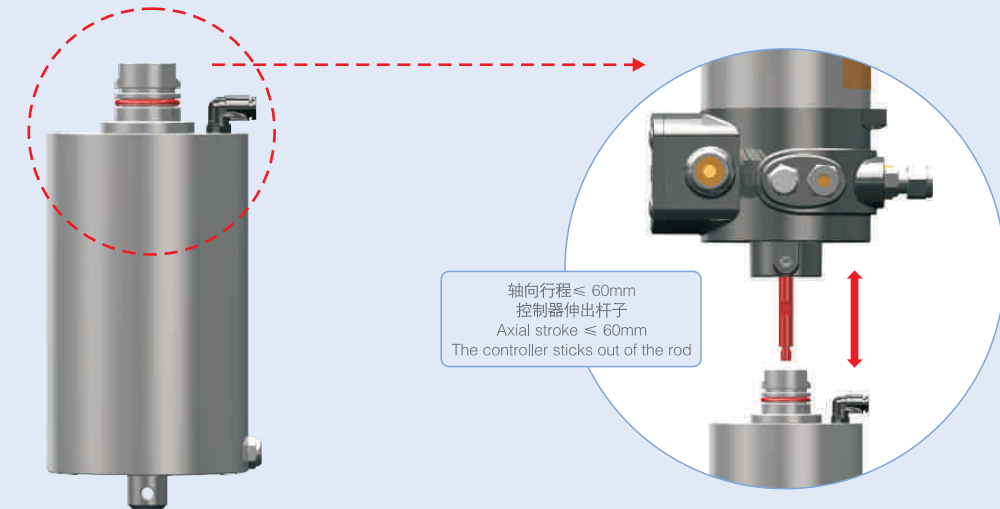

### 立式旋转行程阀门控制器-通用性

#### Vertical rotary stroke Valve controller - universal

立式旋转行程阀门控制器，具有非常强的通用性它可以适配到各种旋转行程气动阀门顶部，如气动蝶阀、气动球阀等。

Vertical rotary stroke valve controller, with very strong versatility it can be adapted to the top of a variety of rotary stroke pneumatic valves, such as pneumatic butterfly valves, pneumatic ball valves, etc.

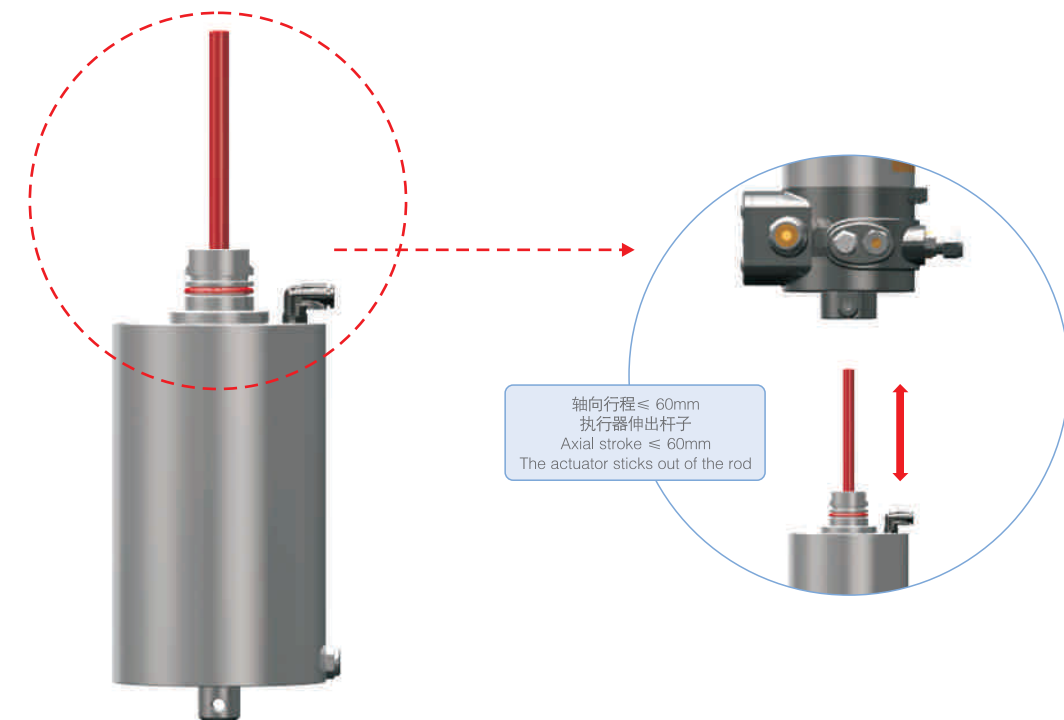
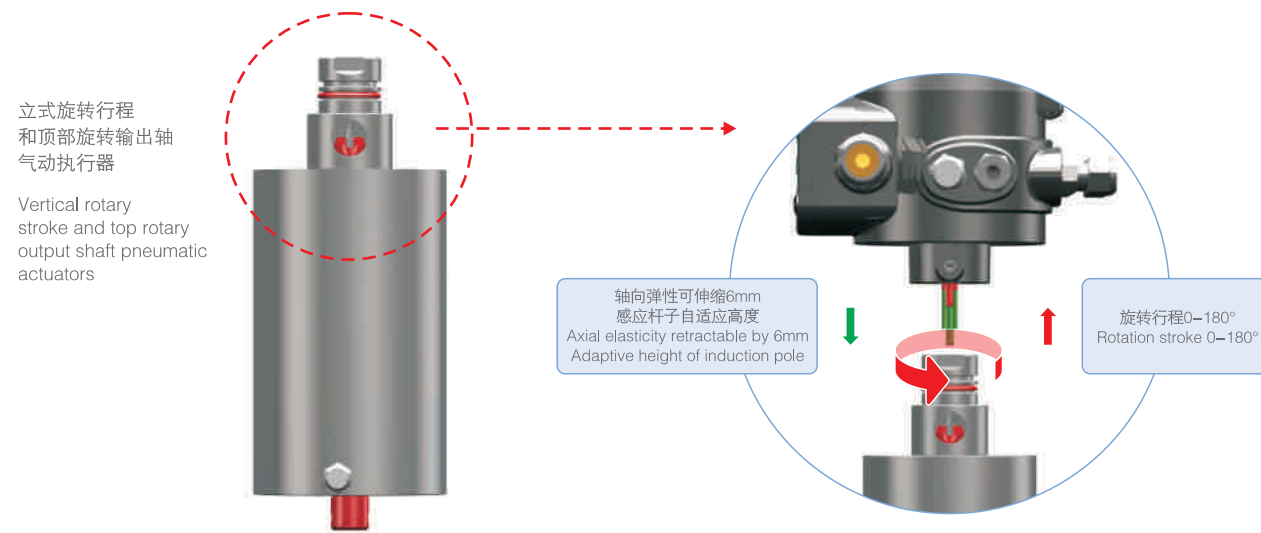



# IO-Link V1.1 接口通讯

## IO-Link V1.1 Communication interface



IO-Link-配件与国际一些品牌合作 IFM Pepperl+Fuchs SIEMENS  
IO-Link- accessories cooperate with some international brands IFM Pepperl+Fuchs SIEMENS

IO-Link ID: 1641(OX0669)



主站品牌Master station brands: IFM Pepperl+Fuchs SIEMENS  
IO-LINK主站支持8个接口或4个接口  
IO-LINK master station supports 8 or 4 interfaces

通讯协议Communication protocol:  
IO-Link → PROFINET; IO-Link → EtherNet/IP; IO-Link → Modbus TCP



主站通讯线适用于 A模式和B模式  
The master station communication line is suitable for both Mode A and Mode B

型号Model	DJ-E11898-2M	DJ-E12491-5M	DJ-E12204-10M
线长Line length	2M	5M	10M



从站通讯线适用于A模式和B模式  
The slave communication line is suitable for both mode A and mode B

型号Model	DJ-HC-D-NZ/WZ-5-2-PUR	DJ-HC-D-NZ/WZ-5-3-PUR	DJ-HC-D-NZ/WZ-5-5-PUR
线长Line length	2M	3M	5M

注意: 具体有关电缆接头等参数, 详见下页电缆接头有关章节  
Note: For specific parameters such as cable connectors, see the relevant sections on cable connectors on the next page

# AS-Interface 接口通讯

## AS-Interface communication interface



AS-Interface-配件与国际一些品牌合作 IFM Pepperl+Fuchs SIEMENS  
AS-Interface- accessories cooperate with some international brands IFM Pepperl+Fuchs SIEMENS



网关品牌Gateway brands: IFM Pepperl+Fuchs SIEMENS  
AS-I 每个网关B模式下 支持62个ID  
AS-I supports 62 IDs per gateway B mode  
通讯协议Communication protocol:  
AS-I → PROFINET; AS-I → EtherNet/IP; AS-I → Profibus DP



AS-I专用扁平电缆  
AS-I special flat cable



AS-I专用连接器 AS-I special connector



从站通讯线适用于A模式和B模式  
The slave communication line is suitable for both mode A and mode B

型号Model	DJ-HC-S-NZ/0-5-2-PUR	DJ-HC-D-NZ/0-5-3-PUR	DJ-HC-D-NZ/0-5-5-PUR
线长Line length	2M	3M	5M

注意: 具体有关电缆接头等参数, 详见下页电缆接头有关章节  
Note: For specific parameters such as cable connectors, see the relevant sections on cable connectors on the next page

# DONJOY-阀门控制器可适用于不同厂家的阀门 DONJOY-Valve controller is available for different manufacturers of valves



DONJOY-阀门控制器 C-TOP、IL-TOP、F-TOP等系列产品可适配于如下阀门品牌

Donjoy-valve controller C-TOP, IL-TOP, F-TOP and other products can be adapted to the following valve brands

- Alfa Laval
- APV/SPX
- Aseptomag
- Bardiani
- Definox
- GEA
- Kieselmann
- Nocado
- Tyco Hovap
- GEMU
- burkert

我们的阀门控制器不仅适配于以上阀门品牌，也可适配于中国、国际其他厂家阀门  
Our valve controller is not only suitable for the above valve brands, but also suitable for other Chinese and international manufacturers of valves



## Alfa Laval阀门适配器 Valve adapter

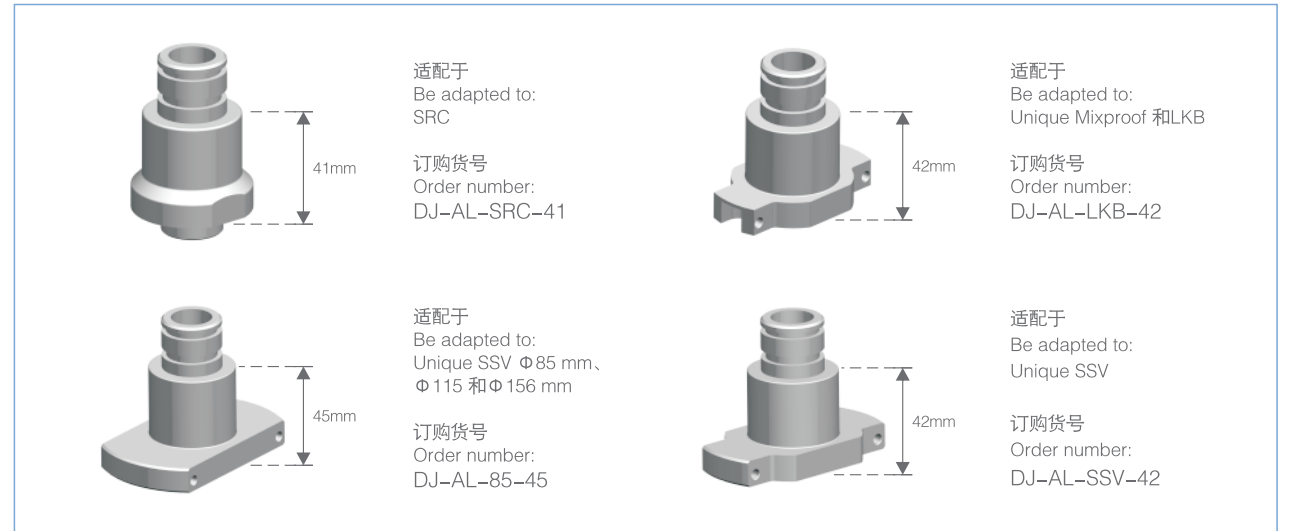

## APV/SPX阀门适配器 Valve adapter



## Definox阀门适配器 Valve adapter

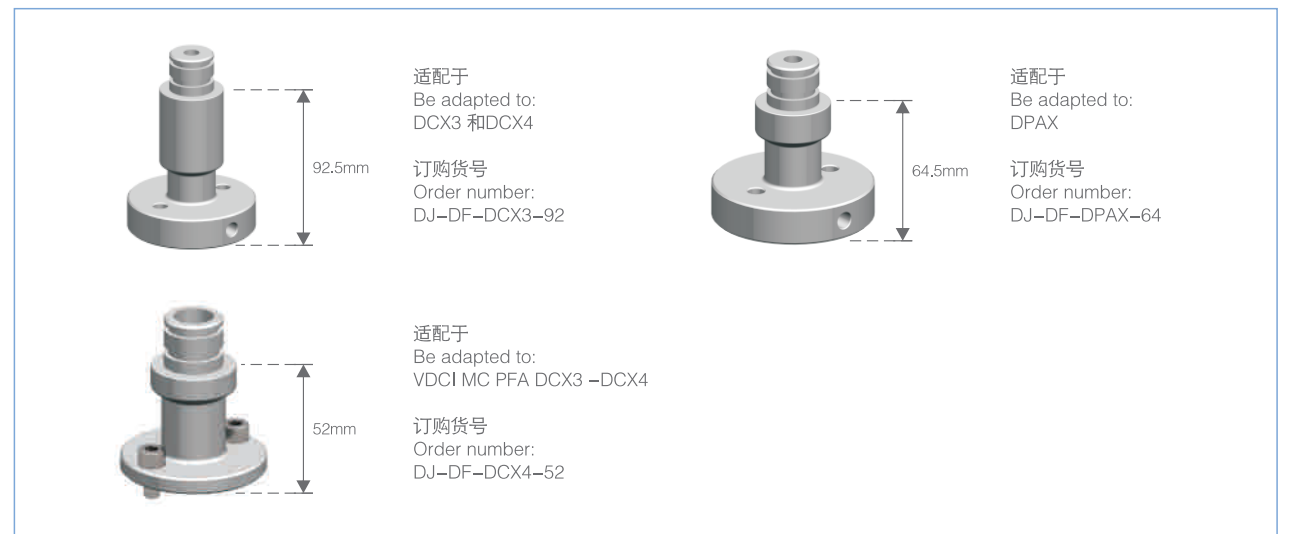



**DONJOY-阀门控制器可适用于不同厂家的阀门**  
**DONJOY-Valve controller is available for different manufacturers of valves**

**Bardiani阀门适配器 Valve adapter**

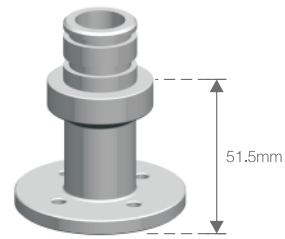

适配于  
Be adapted to:  
PA80100 mm  
订购货号  
Order number:  
DJ-BA-PA80-51

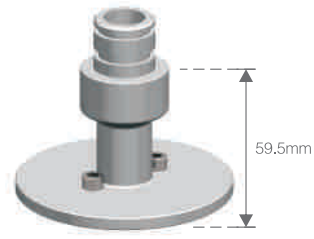

适配于  
Be adapted to:  
ZD90  
订购货号  
Order number:  
DJ-BA-ZD90-59

**GEA阀门适配器 Valve adapter**

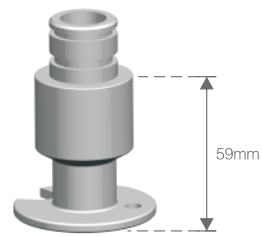

适配于  
Be adapted to:  
SCAMI  
订购货号  
Order number:  
DJ-GE-SCAMI-59

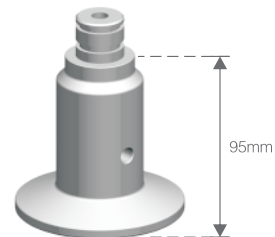

适配于  
Be adapted to:  
T-Smart 7-T-Smart 9  
订购货号  
Order number:  
DJ-GE-Smart-95

**Nocado阀门适配器 Valve adapter**

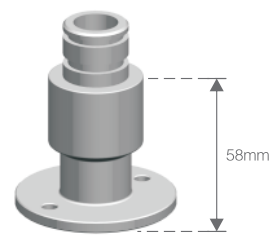

适配于  
Be adapted to:  
H100  
订购货号  
Order number:  
DJ-NC-H100-58

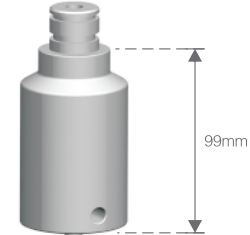

适配于  
Be adapted to:  
Mixproof  $\Phi$ 89 mm  
订购货号  
Order number:  
DJ-NC-Mix-99

**Aseptomag阀门适配器 Valve adapter**

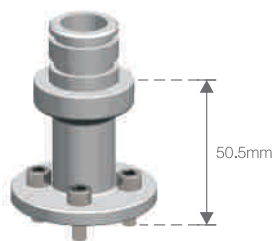

适配于  
Be adapted to:  
BBZPM、ZAW  
订购货号  
Order number:  
DJ-AT-BBZ-50

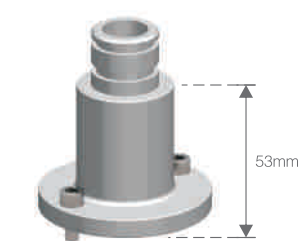

适配于  
Be adapted to:  
直线型气动阀门  
Linear pneumatic valve  
订购货号  
Order number:  
DJ-KM-ALL-53

**Kieselmann阀门适配器 Valve adapter**

**Tyco Hovap阀门适配器 Valve adapter**

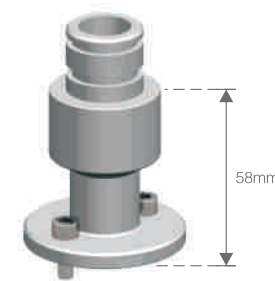

适配于  
Be adapted to:  
BASICFLOW 9600-9630  
订购货号  
Order number:  
DJ-TC-9600-58

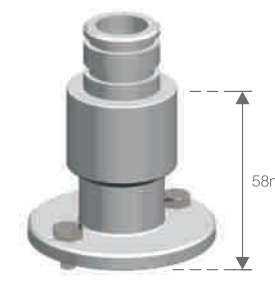

适配于  
Be adapted to:  
BASICFLOW 9800  
订购货号  
Order number:  
DJ-TC-9800-58

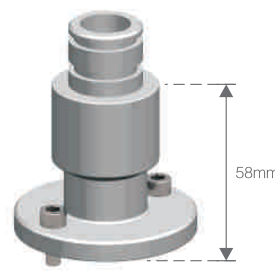

适配于  
Be adapted to:  
VARIFLOW 87XX  
订购货号  
Order number:  
DJ-TC-87XX-58

**GEMU阀门适配器 Valve adapter**



适配于  
Be adapted to:  
隔膜阀、角座阀系列  
Diaphragm valve  
Angle seat valve series

订购货号  
Order number:  
DJ-GM-ALL-TY

**INOXPA阀门适配器 Valve adapter**

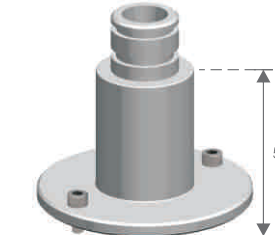

适配于  
Be adapted to:  
T2  
订购货号  
Order number:  
DJ-IN-T2-56

**Burkert 阀门适配器 Valve adapter**



适配于  
Be adapted to:  
隔膜阀、角座阀系列  
Diaphragm valve  
Angle seat valve series

订购货号  
Order number:  
DJ-BK-ALL-TY

## 气源附件-电磁阀系列

### Air source accessories-Solenoid valve series

电磁阀与国际一线品牌厂家合作 FESTO、SMC、ASCO、NORGREN、AIRTAC，其包含侧面帖板式、气管连接式等电磁阀。

Solenoid valve cooperate with the international famous brand manufacturers such as FESTO, SMC, ASCO, NORGREN, AIRTAC, which includes the side plate, air pipe connection type solenoid valve.

- 供电: DC24V AC 220V/110V
- 安全等级: 通用等级  
隔爆等级 Exd II CT6  
本安防爆等级 Exiall CT6
- Power supply: DC24V AC 220V/110V
- Safety level: General level  
Flameproof rating Exd II CT6  
Intrinsic safety explosion-proof class Exiall CT6

#### 电磁阀-侧面安装式 Solenoid valve - side mount type



#### 电磁阀-配管连接式 Solenoid valve - pipe connection type



#### 隔爆电磁阀 Flameproof solenoid valve



#### 订购型号定义 Order type definition

DJ-VDC-DC24 -2/3- C -EXD -1/4-SMC



## 气源附件-过滤减压阀系列

### Air source accessories-filter reducing valve series

过滤减压阀与国际一线品牌厂家合作 FESTO、SMC、ASCO、NORGREN、AIRTAC，其包含不锈钢、铝合金等。

Filter pressure reducing valve cooperat with the international famous brand manufacturers such as FESTO, SMC, ASCO, NORGREN, AIRTAC, which contains stainless steel, aluminum alloy, etc.

#### 油雾过滤减压阀系列 Oil mist filter reducing valve series



#### 订购型号定义 Order type definition

DJ-VGL- S -1/4-AL-SMC - EX





# 传感器与电缆 Sensor and cable

## 位置接近开关系列 Position proximity switch series

位置开关系列与国际一线品牌厂家合作 P+F、IFM、honeywell  
Position switch series cooperate with the international famous brand manufacturers such as P+F, IFM, honeywell



### 订购型号定义 Order type definition

DJ-CGQ- A - M12-40-N- P+F Exd

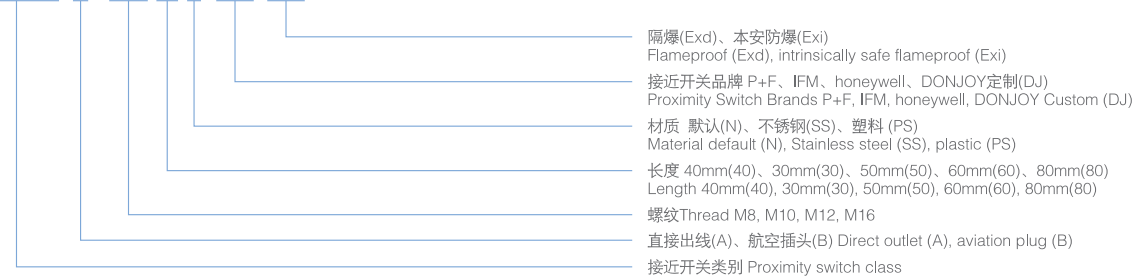

## 电缆系列 Cable series

多针孔电缆接头系列与国际一线品牌厂家合作 P+F、IFM、DOJOY定制  
Multi-pinhole cable connector series is customized by P+F, IFM and DOJOY in cooperation with international famous brand manufacturers



接口螺纹 Interface thread: M12\*1  
防护等级 Protection level: IP67  
最高电压 Maximum voltage: ≤ 250V

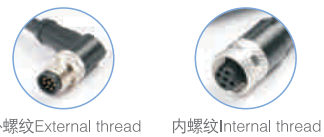

### 订购型号定义 Order type definition

DJ-HC-D- NW/NZ-5-1.5-PUR-DJ



## 电缆接头系列 Cable connector series

多针孔电缆接头系列与国际一线品牌厂家合作 P+F、IFM、DONJOY定制  
Multi-pinhole cable connector series is customized by P+F, IFM, DONJOY in cooperation with international famous brand manufacturers



内螺纹弯头 Elbow for internal thread		外螺纹弯头 Elbow for external thread		说明 Description
型号 Model	芯数 Cores	型号 Model	芯数 Cores	
DJ-FHC-NW-2	2	DJ-FHC-WW-2	2	接口螺纹: M12*1 防护等级: IP67 最高电压: ≤250V 锁线尺寸: 4-7mm/7-9mm Interface thread: M12*1 Protection level: IP67 Maximum voltage: ≤250V Lock wire size: 4-7mm/7-9mm
DJ-FHC-NW-4	4	DJ-FHC-WW-4	4	
DJ-FHC-NW-5	5	DJ-FHC-WW-5	5	
DJ-FHC-NW-8	8	DJ-FHC-WW-8	8	
DJ-FHC-NW-12	12	DJ-FHC-WW-12	12	

内螺纹直型 Internal thread straight type		外螺纹直型 Straight external thread		说明 Description
型号 Model	芯数 Cores	型号 Model	芯数 Cores	
DJ-FHC-NZ-2	2	DJ-FHC-WZ-2	2	螺纹标准: M12*1 防护等级: IP67 最高电压: ≤250V 锁线尺寸: 4-7mm/7-9mm Thread standard: M12*1 Protection level: IP67 Maximum voltage: ≤250V Lock wire size: 4-7mm/7-9mm
DJ-FHC-NZ-4	4	DJ-FHC-WZ-4	4	
DJ-FHC-NZ-5	5	DJ-FHC-WZ-5	5	
DJ-FHC-NZ-8	8	DJ-FHC-WZ-8	8	
DJ-FHC-NZ-12	12	DJ-FHC-WZ-12	12	

多针孔电缆接头系列与国际一线品牌厂家合作 P+F、IFM、DONJOY定制  
Multi-pinhole cable connector series is customized by P+F, IFM, DONJOY in cooperation with international famous brand manufacturers



外螺纹接口 External thread connection		内螺纹接口 Internal thread connection		底座螺纹 Base thread
型号 Model	芯数 Cores	型号 Model	芯数 Cores	
DJ-DHC-M16-W-2	2	DJ-DHC-M12-N-2	2	M12*1.5
DJ-DHC-M12-W-4	4	DJ-DHC-M12-N-4	4	
DJ-DHC-M12-W-5	5	DJ-DHC-M12-N-5	5	
DJ-DHC-M12-W-8	8	DJ-DHC-M12-N-8	8	

外螺纹接口 External thread connection		内螺纹接口 Internal thread connection		底座螺纹 Base thread
型号 Model	芯数 Cores	型号 Model	芯数 Cores	
DJ-DHC-M16-W-2	2	DJ-DHC-M16-N-2	2	M16*1.5
DJ-DHC-M16-W-4	4	DJ-DHC-M16-N-4	4	
DJ-DHC-M16-W-5	5	DJ-DHC-M16-N-5	5	
DJ-DHC-M16-W-8	8	DJ-DHC-M16-N-8	8	
DJ-DHC-M16-W-12	12	DJ-DHC-M16-N-12	12	

# 电缆接头 Cable joint

## 电缆接头系列 Cable connector series

多针孔电缆接头系列与国际一线品牌厂家合作 P+F、IFM、DONJOY定制  
Multi-pinhole cable connector series is customized by P+F, IFM, DONJOY in cooperation with international famous brand manufacturers

### DJ-GLT-M16-PS-4-8-EXD-P+F

- 品牌 Brand P+F、IFM、HUMMEL、donjoy定制 Custom (DJ)
- 隔爆(Exd)、本安防爆(Exi)、阻燃(Exe)、无(NO) Flameproof (Exd), intrinsically safe and explosion-proof (Exi), flame retardant (Exe)
- 锁线 Lock lines 2-5、3-7、5-10、7-12、8-16
- 塑料 Plastic Ps、不锈钢 Stainless steel SS
- 螺纹 Thread M12、M16、M20
- 类别 Category DJ-GLT



型号 Model	螺纹 Thread	锁线尺寸 Lock wire size
DJ-GLT-M16-SS-7-12-Exd-DJ	M16*1.5	7-12mm
DJ-GLT-M16-SS-8-16-Exd-DJ		8-16mm
DJ-GLT-M20-SS-7-12-Exd-DJ	M20*1.5	7-12mm
DJ-GLT-M20-SS-8-16-Exd-DJ		8-16mm



型号 Model	螺纹 Thread	锁线尺寸 Lock wire size
DJ-GLT-M12-PS-2-5	M12*1.5	2-5mm
DJ-GLT-M12-PS-3-7		3-7mm
DJ-GLT-M16-PS-3-7	M16*1.5	3-7mm
DJ-GLT-M16-PS-5-10		5-10mm
DJ-GLT-M20-PS-5-10	M20*1.5	5-10mm
DJ-GLT-M20-PS-7-12		7-12mm



型号 Model	螺纹 Thread	锁线尺寸 Lock wire size
DJ-GLT-M12-SS-2-5	M12*1.5	2-5mm
DJ-GLT-M12-SS-3-7		3-7mm
DJ-GLT-M16-SS-3-7	M16*1.5	3-7mm
DJ-GLT-M16-SS-5-10		5-10mm
DJ-GLT-M20-SS-5-10	M20*1.5	5-10mm
DJ-GLT-M20-SS-7-12		7-12mm

# 气源接头 Air source joint

## 电缆接头系列 Cable connector series

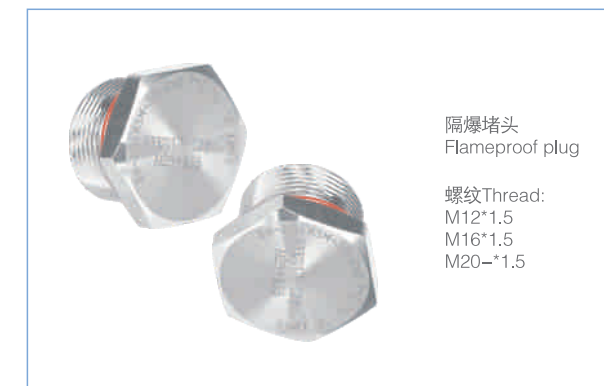

## 气源接头系列 Air source connectors series

